

DS-2TD1228T-2/QA Bi-spectrum Thermography Network Turret Camera



Hikvision DS-2TD1228T-2/QA Bi-spectrum Thermography Network Turret Camera can be applied to warehouses, construction sites, waste incineration plants, manufacturing workshops, etc. The accurate temperature measurement device sends temperature exception alarms for loss prevention.

- 256 × 192 resolution, 12 μm, VOx UFPA, NETD < 40 mK (25°C, F1.0)
- Video content analysis: vehicle/human classification
- Temperature exception alarm for fire prevention, -20°C to 550°C (-4°F to 1,022°F), Max (± 2°C, ± 2%)
- Support smoke detection algorithm
- Image processing technology: linear, histogram, self-adaptive thermal AGC mode, DDE, 3D DNR
- High quality detector with 10 years guarantee
- Support smoke detection algorithm
- Support sun-reflection filter and forklift alarm filter algorithm

▪ Specification

| Thermal Module | |
|--------------------------|---|
| Image Sensor | Vanadium Oxide Uncooled Focal Plane Arrays |
| Resolution | 256 x 192 |
| Pixel Pitch | 12 μm |
| Spectral Range | 8 μm to 14 μm |
| NETD | $\leq 40 \text{ mK}$ (@25° C, F# = 1.0) |
| Focal Length | 2.1 mm |
| IFOV | 5.71 mrad |
| Aperture | F1.0 |
| Field of View | 90.0° × 65.4° (H × V) |
| Min. Focusing Distance | 0.1 m |
| Digital Zoom | ×2, ×4 |
| Optical Module | |
| Image Sensor | 1/2.7" Progressive Scan CMOS |
| Resolution | 2688 × 1520 |
| Min. Illumination | 0.0176Lux @(F2.25,AGC ON) ,0 Lux with IR |
| Field of View | 117.8° × 70.4° (H × V) |
| Focal Length | 2.2 mm |
| Shutter Speed | 1 s to 1/100,000 s |
| White Balance | MWB/AWB1/Locked WB/Fluorescent Lamp/Incandescent Lamp/Warm Light Lamp/Natural Light |
| Day & Night Mode | IR Cut Filter with Auto Switch |
| WDR | 120 dB |
| Aperture | F 2.25 |
| Image Effect | |
| Bi-spectrum Image Fusion | Display the details of optical channel on thermal channel |
| Picture in Picture | Display partial image of thermal channel on the full screen of optical channel |
| Target Coloration | Yes. Supported in white hot and black hot mode. |
| Illuminator | |
| IR Distance | Up to 15 m |
| IR Intensity and Angle | Automatically adjusted |
| Audible and Visual Alarm | |
| White Light Range | Up to 30 m |
| Visual Alarm | Yes. White light alarm with adjustable flashing frequencies |
| Audio alarm | Yes, for three types of audible alarm (VCA and Temperature Exception) 3 preset voice alerts (one for each) 6 importable user-defined voice alerts (6 options shared in the two types) |

| Smart Function | |
|-------------------------|---|
| VCA | 4 VCA rule types (line crossing, intrusion, region entrance, and region exiting), up to 8 VCA rules in total. |
| Temperature Measurement | 3 temperature measurement rule types, 21 rules in total (10 points, 10 areas, and 1 line) |
| Temperature Range | -20°C to 550°C (-4°F to 1022°F); |
| Temperature Accuracy | Max (±2°C, ±2 %) |
| General Function | Fire detection, smoke detection, smoking detection, sun-reflection filter, forklift alarm filter |
| Video and Audio | |
| Main Stream | Thermal: 25 fps (1280 × 720, 704 × 576, 640 × 512, 320 × 240) Optical: 50 Hz: 25 fps (2688 × 1520, 1920 × 1080, 1280 × 720) 60Hz: 30 fps (2688 × 1520, 1920 × 1080, 1280 × 720) |
| Sub-stream | Thermal: 25 fps (704 × 576, 640 × 512, 320 × 240) Optical: 50 Hz: 25 fps (704 × 576, 352 × 288) 60 Hz: 30 fps (704 × 480, 352 × 240) |
| Video Compression | Main Stream: H.265/H.264 Sub-Stream: H.265/H.264/MJPEG |
| Audio Compression | G.722.1/G.711ulaw/G.711alaw/MP2L2/G.726/PCM |
| Network | |
| Protocols | IPv4/IPv6, HTTP, HTTPS, 802.1x, QoS, FTP, SMTP, UPnP, SNMP, DNS, DDNS, NTP, RTSP, RTCP, RTP, TCP, UDP, IGMP, ICMP, DHCP, PPPoE,TP,Bonjour,SFTP,SRTP,TLS |
| Network Storage | MicroSD/SDHC/SDXC card (up to 256 G) local storage, NAS (NFS, SMB/CIFS), Auto Network Replenishment (ANR) |
| API | ISAPI, HIKVISION SDK, ISUP, and third-party management platform, Open Network Video Interface,ONVIF (Profile S, Profile G) |
| Simultaneous Live View | Up to 20 channels |
| User/Host level | Up to 32 users, 3 levels: Administrator, Operator, User |
| Security | User authentication (ID and password), MAC address binding, HTTPS encryption, IEEE 802.1x access control, IP address filtering |
| Client | iVMS-4200, Hik-Connect |
| Interface | |
| Alarm Input | 1, alarm input (0-5 VDC) |
| Alarm Output | 1, alarm output (alarm response actions configurable) |
| Alarm Action | SD recording/Relay output/Smart capture/FTP upload/Email linkage |
| Audio Input | 1, 3.5 mm Mic in/Line in interface Line input: 2 - 2.4 V [p-p], output impedance: 1 KΩ ± 10% |

| | |
|------------------------------|---|
| Audio Output | Linear level, impedance: 600 Ω |
| Communication Interface | 1, RJ45 10 M/100 M Self-adaptive Ethernet interface. 1, RS-485 interface (half duplex) |
| General | |
| Menu Language | 32 languages English, Russian, Estonian, Bulgarian, Hungarian, Greek, German, Italian, Czech, Slovak, French, Polish, Dutch, Portuguese, Spanish, Romanian, Danish, Swedish, Norwegian, Finnish, Croatian, Slovenian, Serbian, Turkish, Korean, Traditional Chinese, Thai, Vietnamese, Japanese, Latvian, Lithuanian, Portuguese (Brazil) |
| Power Supply | 12 VDC ± 25%, φ 5.5 mm coaxial power plug PoE (802.3af, class 3) |
| Power Consumption | 12 VDC ± 25%: 0.5 A, Max 6 W PoE (802.3af, class 3): 42.5 V to 57 V, 0.14 A to 0.22 A, Max 6.5 W |
| Working Temperature/Humidity | Temperature: -40°C to 65°C (-40°F to 149°F) Humidity: 95% or less |
| Protection Level | IP67 Standard TVS 4000V lightning protection, surge protection, voltage transient protection |
| Dimensions | 138.3 mm × 138.3 mm × 123.1 mm (5.45" × 5.45" × 4.85") |
| Weight | 940 g (2.07 lb) |

▪ Range Table

| VCA Range (Vehicles: 1.4 × 4.0 m) | VCA Range (Humans: 1.8 × 0.5 m) | Temperature Measurement (Object: 0.2 × 0.2 m) | Temperature Measurement (Object: 1 × 1 m) | Fire Detection (Object: 0.2 × 0.2 m) | Smoke Detection (Object: 0.5 × 0.5m) | Smoking Detection |
|--------------------------------------|------------------------------------|--|--|---|---|-------------------|
| 50.4. m | 16.8m | 7 m | 35 m | 25.2m | 6.6m | 3.15m |

▪ DORI

* The table is only for reference and the performance may vary according to different environment.

* The optimal human detection, recognition, and identification distances are calculated according to Johnson's Criteria.

Detection Range: In order to distinguish an object from the background, the object must be covered by 1.5 or more pixels.

Recognition Range: In order to classify the object (animal, human, vehicle, etc.), the object must be covered by 6 or more pixels.

Identification Range: In order to identify the object and describe it in details, the object must be covered by 12 or more pixels.

| Detection Range (Vehicles: 1.4 × 4.0 m) | Detection Range (Humans: 1.8 × 0.5 m) | Recognition Range (Vehicles: 1.4 × 4.0 m) | Recognition Range (Humans: 1.8 × 0.5 m) | Identification Range (Vehicles: 1.4 × 4.0 m) | Identification Range (Humans: 1.8 × 0.5 m) |
|--|--|--|--|---|---|
| 268 m | 88 m | 67 m | 22 m | 34 m | 11 m |

▪ Available Model

DS-2TD1228T-2/QA

DS-2TD1228T-2/QA(U)





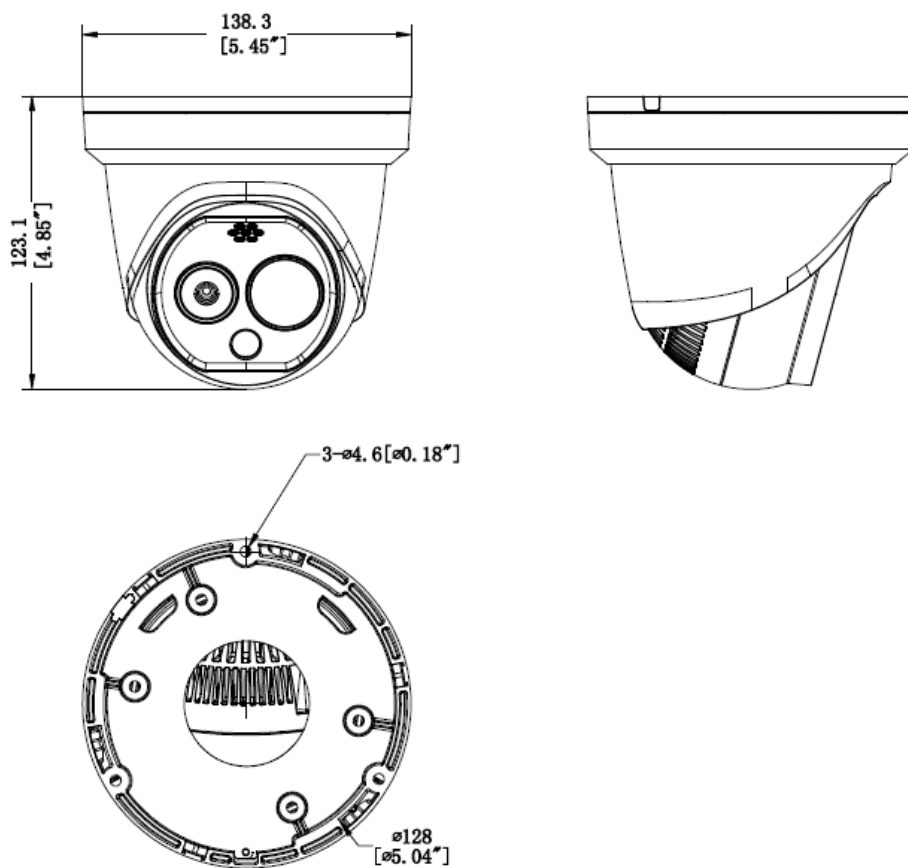

DS-2TD1228T-2/QA(B)

▪ Dimension



▪ **Accessory**

▪ **Optional**

| DS-1273ZJ-140 Wall mount | DS-1273ZJ-140B Wall mount | DS-1271ZJ-140 Pendant Mount | DS-1275ZJ-SUS Vertical pole mount | DS-1276ZJ-SUS Corner mount |
|---|---|---|---|---|
|  |  |  |  |  |
| DS-1280ZJ-DM21 Junction box | DS-1273ZJ-140(BLACK) Wall mount | | | |
|  |  | | | |

COMPLIANCE NOTICE: The thermal series products might be subject to export controls in various countries or regions, including without limitation, the United States, European Union, United Kingdom and/or other member countries of the Wassenaar Arrangement. Please consult your professional legal or compliance expert or local government authorities for any necessary export license requirements if you intend to transfer, export, re-export the thermal series products between different countries.

Headquarters

No.555 Qianmo Road, Binjiang District,
Hangzhou 310051, China
T +86-571-8807-5998
www.hikvision.com



Follow us on social media to get the latest product and solution information.

