

DS-2CD6D54G2-IZHS(/NFC) 4-Directional Multisensor Network Camera



- 4 adjustable lenses in one camera cover up to 360° field of view, ensuring no blind area monitoring and the monitoring tilt angle can be adjusted
- Each lens up to 5 MP, capturing clear images, and more details can be displayed on video wall
- Clear imaging against strong back light due to 120 dB true WDR technology
- Water and dust resistant (IP67) and vandal proof (IK10)
- Human and vehicle target classification based on deep learning for up to 4 channels
- Unique PTRZ capability for efficient installation
- Audio and alarm interface available

▪ Specification

| Camera | |
|-----------------------------|--|
| Image Sensor | 1/2.4" Progressive Scan CMOS |
| Max. Resolution | 2560 × 1920 |
| Min. Illumination | Color: 0.005 Lux @ (F1.2, AGC ON),B/W: 0.002 Lux @ (F1.2, AGC ON),B/W: 0 Lux with IR |
| Shutter Time | 1 s to 1/100,000 s |
| Day & Night | IR cut filter |
| Angle Adjustment | Pan: 0° to 350°,tilt: 0° to 90°,rotate: -90° to 90° |
| Lens | |
| Lens Type | Varifocal lens, motorized lens, 2.8 to 8 mm |
| Focal Length & FOV | 2.8 to 8 mm, horizontal FOV 96.5° to 48.9°, vertical FOV 69.9° to 36.5°, diagonal FOV 129° to 61.3° |
| Lens Mount | Ø14 |
| Focus | Semi-auto,Manual |
| Aperture | F1.9 |
| Illuminator | |
| Supplement Light Type | IR |
| Supplement Light Range | Up to 30 m |
| IR Wavelength | 850 nm |
| Video | |
| Main Stream | 50 Hz: 25 fps (2560× 1920, 2048× 1536, 1920 × 1080, 1280 × 720) 60 Hz: 30 fps (2560× 1920, 2048× 1536, 1920 × 1080, 1280 × 720) |
| Sub-Stream | 50 Hz: 25 fps (704 × 576, 640 × 480) 60 Hz: 30 fps (704 × 480, 640 × 480) |
| Third Stream | 50 Hz: 25 fps (1920 × 1080, 1280 × 720, 704 × 576, 640 × 480) 60 Hz: 30 fps (1920 × 1080, 1280 × 720, 704 × 576, 640 × 480) |
| Video Compression | Main stream: H.265+/H.265/H.264+/H.264, Sub-stream: H.265/H.264/MJPEG, Third stream: H.265/H.264 |
| Video Bit Rate | 32 Kbps to 8 Mbps |
| H.264 Type | Baseline Profile,Main Profile,High Profile |
| H.265 Type | Main Profile |
| Scalable Video Coding (SVC) | H.264 and H.265 encoding |
| Region of Interest (ROI) | 4 fixed regions for each stream |
| Target Cropping | Yes |
| Audio | |
| Audio Compression | G.711/G.722.1/G.726/MP2L2/PCM/MP3/AAC-LC |
| Audio Bit Rate | 64 Kbps (G.711ulaw/G.711alaw)/16 Kbps (G.722.1)/16 Kbps (G.726)/32 to 192 Kbps (MP2L2)/8 to 320 Kbps (MP3)/16 to 64 Kbps (AAC-LC) |
| Audio Sampling Rate | 8 kHz/16 kHz/32 kHz/48 kHz |
| Environment Noise Filtering | Yes |

| Network | |
|--------------------------|--|
| Protocols | TCP/IP, ICMP, HTTP, HTTPS, FTP, DHCP, DNS, DDNS, RTP, RTSP, RTCP, PPPoE, NTP, UPnP, SMTP, SNMP, IGMP, 802.1X, QoS, IPv4, IPv6, UDP, Bonjour, WebSocket, WebSockets, SSL/TLS |
| Simultaneous Live View | Up to 20 channels |
| API | Open Network Video Interface (Profile S, Profile G, Profile T),ISAPI,SDK,ISUP |
| User/Host | Up to 32 users 3 user levels: administrator, operator, and user |
| Security | Password protection, complicated password, HTTPS encryption, 802.1X authentication (EAP-MD5), watermark, IP address filter, basic and digest authentication for HTTP/HTTPS, WSSE and digest authentication for Open Network Video Interface |
| Network Storage | NAS (NFS, SMB/CIFS),Auto Network Replenishment (ANR), Together with high-end Hikvision memory card, memory card encryption and health detection are supported. |
| Client | iVMS-4200,Hik-Connect |
| Web Browser | Plug-in required live view: IE 10, IE 11, Plug-in free live view: Chrome 57.0+, Firefox 52.0+, Edge 89+, Safari 11+, Local service: Chrome 57.0+, Firefox 52.0+, Edge 89+ |
| Image | |
| Image Settings | Rotate mode,saturation,brightness,contrast,sharpness,AGC,white balance,adjustable by client software or web browser |
| Day/Night Switch | Day,Night,Auto,Schedule,Alarm Trigger |
| Wide Dynamic Range (WDR) | 120 dB |
| SNR | ≥ 52 dB |
| Image Stabilization | EIS |
| Image Enhancement | BLC,HLC,3D DNR,Defog |
| Privacy Mask | 8 programmable polygon privacy masks |
| Picture Overlay | LOGO picture can be overlaid on video with 128 × 128 24 bit bmp format. |
| Interface | |
| Ethernet Interface | 1 RJ45 10 M/100 M/1000 M self-adaptive Ethernet port |
| On-Board Storage | Built-in memory card slot, support microSD/microSDHC/microSDXC card, up to 1 TB |
| Audio | 1 input (line in), 3.5 mm connector, max. input amplitude: 3.3 Vpp, input impedance: 4.7 KΩ, interface type: non-equilibrium, 1 output (line out), 3.5 mm connector, max. output amplitude: 3.3 Vpp, output impedance: 100 Ω, interface type: non-equilibrium |
| Alarm | 2 inputs, 2 outputs (max. 24 VDC, 1 A) |
| RS-485 | 1 RS-485 (Half duplex, HIKVISION, Pelco-P, Pelco-D, self-adaptive) |
| Reset Key | Yes |
| Fiber Optical | /NFC: 1 FC fiber optical interface, SFP module, single mode, 20 km transmission distance, 1310 nm (TX) and 1550 nm (RX), 1250 Mbps transmission rate |
| Event | |
| Basic Event | Motion detection,video tampering alarm,network disconnected,IP address conflict,illegal login,HDD full,HDD error |

| | |
|----------------------------------|---|
| Smart Event | Line crossing detection, intrusion detection, region entrance detection, region exiting detection (support alarm triggered by specified target types (human and vehicle)),scene change detection, unattended baggage detection,object removal detection |
| Linkage | Upload to FTP/NAS/memory card,notify surveillance center,send email,trigger alarm output,trigger recording,trigger capture |
| Deep Learning Function | |
| Perimeter Protection | Line crossing, intrusion, region entrance, region exiting Support alarm triggering by specified target types (human and vehicle) |
| General | |
| Power | 12 VDC \pm 20%, 1.8 A, max. 21.6 W, PoE: IEEE 802.3at, Type 2, Class 4, 42.5 V to 57 V, 0.58 A to 0.43 A, max. 25 W |
| Dimension | \varnothing 290 mm \times 148 mm (\varnothing 11.42" \times 5.8") |
| Package Dimension | 453 mm \times 393 mm \times 385 mm (17.8" \times 15.47" \times 15.16") |
| Weight | Approx. 4.7 kg (10.36 lb.) |
| With Package Weight | Approx. 8.0 kg (17.63 lb.) |
| Storage Conditions | -40 $^{\circ}$ C to 60 $^{\circ}$ C (-40 $^{\circ}$ F to 140 $^{\circ}$ F). Humidity 95% or less (non-condensing) |
| Startup and Operating Conditions | -40 $^{\circ}$ C to 60 $^{\circ}$ C (-40 $^{\circ}$ F to 140 $^{\circ}$ F). Humidity 95% or less (non-condensing) |
| Language | 33 languages: English, Russian, Estonian, Bulgarian, Hungarian, Greek, German, Italian, Czech, Slovak, French, Polish, Dutch, Portuguese, Spanish, Romanian, Danish, Swedish, Norwegian, Finnish, Croatian, Slovenian, Serbian, Turkish, Korean, Traditional Chinese, Thai, Vietnamese, Japanese, Latvian, Lithuanian, Portuguese (Brazil), Ukrainian |
| General Function | Heartbeat,flash log,password reset via email,pixel counter,password protection,one-key reset,anti-banding |
| Approval | |
| EMC | CE-EMC: EN 55032:2015+A1:2020, EN 50130-4:2011+A1:2014, EN IEC 61000-3-2:2019+A1:2021, EN 61000-3-3:2013+A1:2019+A2:2021, EN 50121-4:2016+A1:2019, RCM: AS/NZS CISPR 32: 2015, IC: ICES-003: Issue 7, KC: KN32: 2015, KN35: 2015 |
| Safety | UL: UL 62368-1, CB: IEC 62368-1: 2014+A11, CE-LVD: EN 62368-1: 2014/A11: 2017, BIS: IS 13252 (Part 1): 2010/IEC 60950-1: 2005 |
| Environment | CE-RoHS: 2011/65/EU, WEEE: 2012/19/EU, Reach: Regulation (EC) No 1907/2006 |
| Protection | IP67: IEC 60529-2013,IK10: IEC 62262:2002 |
| Anti-Corrosion Protection | NEMA 4X (NEMA 250-2018) |

▪ DORI

The DORI (detect, observe, recognize, identify) distance gives the general idea of the camera ability to distinguish persons or objects within its field of view. It is calculated based on the camera sensor specification and the criteria given by EN 62676-4: 2015.

| DORI | Detect | Observe | Recognize | Identify |
|-----------------|---------|---------|-----------|----------|
| Distance (Wide) | 63.7 m | 25.3 m | 12.7 m | 6.4 m |
| Distance (Tele) | 120.5 m | 47.8 m | 24.1 m | 12.1 m |

▪ Typical Application

Hikvision products are classified into three levels according to their anti-corrosion performance. Refer to the following description to choose for your using environment.

This model has MODERATE PROTECTION.

| Level | Description |
|------------------------|--|
| Top-level protection | Hikvision products at this level are equipped for use in areas where professional anti-corrosion protection is a must. Typical application scenarios include coastlines, docks, chemical plants, and more. |
| Moderate protection | Hikvision products at this level are equipped for use in areas with moderate anti-corrosion demands. Typical application scenarios include coastal areas about 2 kilometers (1.24 miles) away from coastlines, as well as areas affected by acid rain. |
| No specific protection | Hikvision products at this level are equipped for use in areas where no specific anti-corrosion protection is needed. |

▪ Available Model

DS-2CD6D54G2-IZHS/NFC(2.8-8mm)





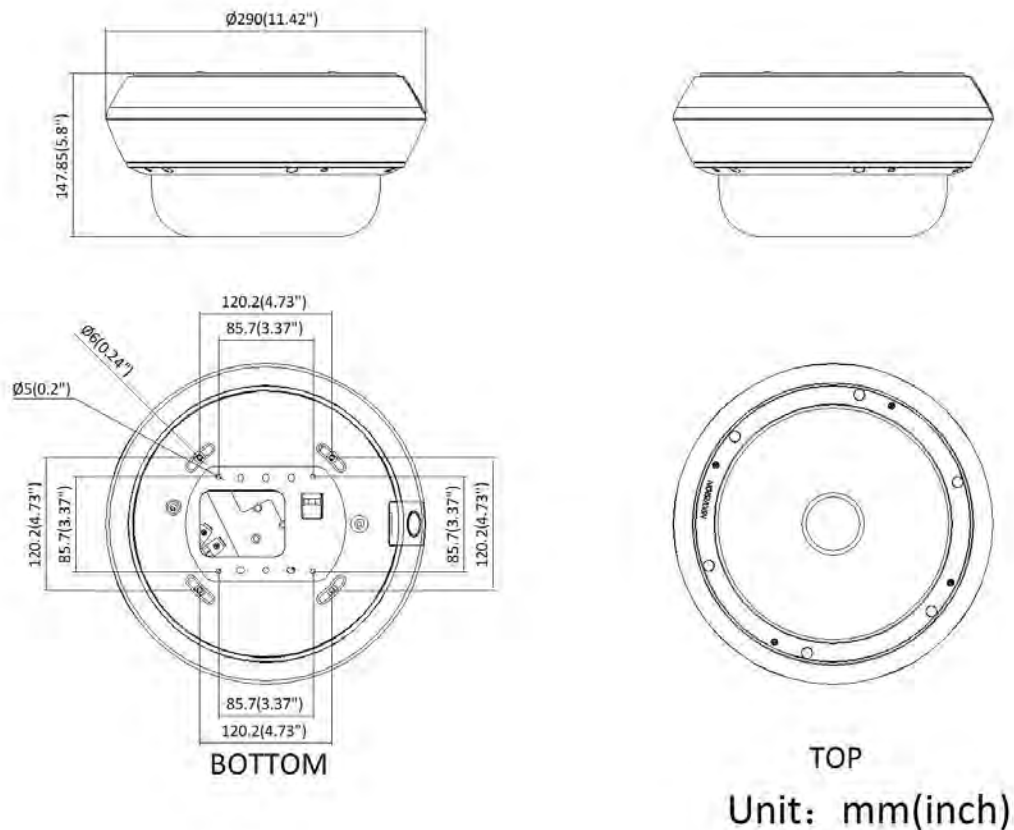

DS-2CD6D54G2-IZHS(2.8-8mm)

▪ **Dimension**



▪ **Accessory**

▪ **Optional**

| DS-1604ZJ Wall mount | DS-1661ZJ Pendant Mount | DS-1673ZJ Vertical pole mount | DS-1604ZJ-pole Vertical pole mount | DS-1663ZJ In-ceiling mount |
|---|---|---|---|---|
|  |  |  |  |  |
| DS-1604ZJ-corner Corner mount | DS-1602ZJ Wall mount | | | |
|  |  | | | |

Headquarters

No.555 Qianmo Road, Binjiang District,
Hangzhou 310051, China
T +86-571-8807-5998
www.hikvision.com



Follow us on social media to get the latest product and solution information.

