



Field Update Line Scan Series

Product Specifications



Features

- High Speed Camera Link Output
- 16K ~ 2K Pixels
- C, F, M42 or M72 Mounts
- Field Update Capability

Safety Precautions

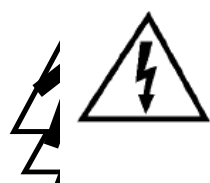
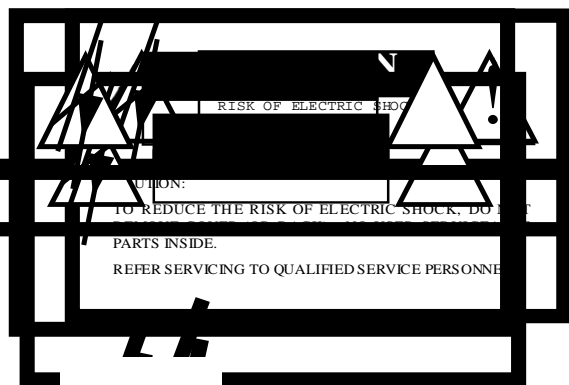

The lightning flash with arrowhead symbol, within an equilateral triangle, is intended to alert the user to the presence of uninsulated "dangerous voltage" within the product's enclosure that may be of sufficient magnitude to constitute a risk of electric shock to persons.

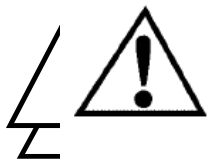

The exclamation point within an equilateral triangle is intended to alert the user to the presence of important operating and maintenance (servicing) instructions in the literature accompanying the appliance.

For U.S.A.

Warning:
This equipment generates and uses radio frequency energy and if not installed and used properly, i.e., in strict accordance with the instruction manual, may cause harmful interference to radio communications. It has been tested and found to comply with the limits for a Class A computing device pursuant to Subpart J of Part 15 of the FCC Rules, which provides for certain protection against such interference when operated in a commercial environment.

For Canada

Warning:
This digital apparatus does not exceed the Class A limits for radio noise emissions from digital apparatus set out in the Radio Interference Regulations of the Canadian Department of Communications.

WARNING:
TO PREVENT FIRE OR SHOCK HAZARD, DO NOT EXPOSE THIS APPLIANCE TO RAIN OR MOISTURE.

Product Precautions

- Handle the camera with care. Do not abuse the camera. Avoid striking or shaking it. Improper handling or storage could damage the camera.
- Do not pull or damage the camera cable.
- During camera use, do not wrap the unit in any material. This will cause the internal temperature of the unit to increase.
- Do not expose the camera to moisture, or do not try to operate it in wet areas.
- Do not operate the camera beyond its temperature, humidity and power source ratings.
- While the camera is not being used, keep the lens or lens cap on the camera to prevent dust or contamination from getting in the CCD or filter area and scratching or damaging this area.
- Do not keep the camera under the following conditions:
 - In wet, moist, and high humidity areas
 - Under hot direct sunlight
 - In high temperature areas
 - Near an object that releases a strong magnetic or electric field
 - Areas with strong vibrations
- Use a soft cloth to clean the camera. Use pressured air spray to clean the surface of the glass. DO not scratch the surface of the glass.

Copyright & Disclaimer

Sensor Technologies America, Inc. (DBA Sentech America) believes the contents and specifications of its website, catalog, documentation and ads are correct; however, Sentech America provides no representation or warranty regarding such information or product(s) contained therein. It is requested that Sentech America be given appropriate acknowledgement in any subsequent use of such work by a third party.

While every effort has been made to ensure that the details contained in Sentech America's website and all documentation are correct and up-to-date, Sentech America assumes no liability, legal or otherwise for any errors in listings, specifications, part numbers, process, software or model applications. Sentech America reserves the right to change specifications, product descriptions, product quality, pricing and application at any time without prior written or oral notice. Any party using such information assumes all risk for any and all damaged caused to themselves, a third party and/or property by virtue of incorrect information and/or failure of these products. By installing and/or using a Sentech America software development kit or other similar product and/or information obtained from Sentech America's website, catalog, documentation or ads, you hereby accept and understand these stated terms and conditions.

Contents

1. General Specifications.....	6
1.1 Electronic Specifications	6
1.2 Optical Specifications.....	6
1.3 Mechanical Specifications.....	7
1.4 Environmental Specifications	7
2. Product Numbering Method.....	8
2.1 Order Number.....	8
3. Connector Specifications	9
3.1 FS-B2KU7CLU	9
3.2 FS-B2KU35CLU, FS-B4KU7DCLU, FS-B4KU35CLU.....	10
3.3 FS-B8KU7CLU, FS-B16KU35CLU	11
3.4 Pin Assignment of the Connectors.....	12
3.5 Bit Assignment	13
3.5.1 Full Configuration.....	13
3.5.2 Medium Configuration.....	14
3.5.3 Base Configuration.....	15
4 Timing Chart.....	16
4.1 Exposure Time.....	16
5 Output Format	19
5.1 FS-B2KU7CLU	19
5.1.1 Video Output format Timing Chart (Base Configuration).....	19
5.1.2 Video Output format Timing Chart “AOI Mode” (Base Configuration).....	19
5.2 FS-B4KU35CLU, FS-B4K7CLU	20
5.2.1 Video Output format Timing Chart (Medium Configuration).....	20
5.2.2 Video Output format Timing chart (Base Configuration)	20
5.2.3 Video Output format Timing chart “AOI Mode” (Base Configuration)	21
5.3 FS-B8KU35CLU, FS-B8KU7CLU	22
5.3.1 Video Output format Timing Chart (Full Configuration).....	23
5.3.2 Video Output format Timing Chart (Medium Configuration).....	24
5.3.3 Video Output format Timing Chart (Base Configuration).....	24
5.3.4 Video Output format Timing Chart “AOI Mode” (Base Configuration).....	24
5.3.5 Video Output format Timing Chart “AOI Mode” (Full Configuration).....	25
5.4 FS-B16KU35CLU	26

5.4.1 Video Output format Timing Chart (Full Configuration).....	27
5.4.2 Video Output Format Timing Chart (Medium Configuration).....	28
5.4.3 Video Output Format Timing Chart (Base Configuration).....	28
5.4.4 Video Output Format Timing Chart “AOI Mode” (Base Configuration).....	28
6. Details of Camera Control.....	29
6.1 Field Flat Correction (FFC).....	29
6.1.1 Summary of FFC.....	29
6.1.2 Technical Terminology.....	29
6.1.3 Auto FFC Procedure.....	30
6.1.4 Manual FFC Procedure.....	33
6.1.5 Confirm FFC.....	33
6.1.6 Save FFC.....	33
6.1.7 FFC Corrected Value Store Mode.....	34
7 Communication Protocol Specifications.....	35
7.1 Communication Method.....	35
7.1.1 Communication Settings.....	35
7.1.2 Communication Format.....	36
7.2 Camera Control Commands.....	38
7.2.1 Camera Control Command List.....	38
7.2.2 Save the Camera Setting Data into FLASH.....	44
7.2.3 Sequence of Camera Power On.....	44
8 Test Patterns.....	45
8.1 FS-B2KU7CLU.....	45
8.2 FS-B4KU7CLU / FS-B4KU35CLU.....	46
8.3 FS-B8KU7CLU / FS-B8KU35CLU.....	47
8.4 FS-B16KU35CLU.....	47
9. Field Update Function.....	48
9.1 Procedure.....	48
10 Quantum Efficiency.....	49
11 Dimensions.....	50
11.1 FS-B2KU7DCLU-C.....	50
11.2 FS-B8KU35CLU-F, FS-B4KU7CLU-F, FS-B4KU35CLU-F, FS-B2KU7CLU-F.....	50
11.3 FS-B16KU35CLU-M72, FS-B8KU7CLU-M72.....	51

1. General Specifications

1.1 Electronic Specifications

Model	FS-B16KU35CLU	FS-B8KU7CLU	FS-B8KU35CLU	FS-B4KU7CLU	FS-B4KU35CLU	FS-B2KU7CLU
Image Sensor	16k CMOS image sensor DR-16k-3.5 (AWAIBA)	8k CMOS image sensor DR-8k-7 (AWAIBA)	8k CMOS image sensor DR-8K-3.5 (AWAIBA)	4k CMOS image sensor DR-4K-7 (AWAIBA)	4k CMOS image sensor DR-4K-3.5 (AWAIBA)	2k CMOS image sensor DR-2K-7 (AWAIBA)
Active Pixels	16,384 pixels	8,192 pixels		4,096 pixels		2,048 pixels
Pixel Size	3.5(H) x 3.5(V) μm (3.5 μm pitch)	7(H) x 7(V) μm (7 μm pitch)	3.5(H) x 3.5(V) μm (3.5 μm pitch)	7(H) x 7(V) μm (7 μm pitch)	3.5(H) x 3.5(V) μm (3.5 μm pitch)	7(H) x 7(V) μm (7 μm pitch)
Photo array length	57.344 mm		28.672 mm		14.336 mm	
Maximum Line Rate	40kHz	80kHz	80kHz	80kHz	80kHz	80kHz
Video output	8bit / 10bit					
Power	Input voltage	+12 Vdc to +24 Vdc				
	Consumption	7.2W(TYP)	4.3 W(TYP)	4.3 W(TYP)	2.8W(TYP)	2.8W(TYP)
Communication	RS232 via Camera Link connector					
Function	High speed exposure control External trigger control Flat Field Correction(FFC) FieldUpdate					

1.2 Optical Specifications

Model	FS-B16KU35CLU	FS-B8KU7CLU	FS-B8KU35CLU	FS-B4KU7CLU	FS-B4KU35CLU	FS-B2KU7CLU
Fill Factor	100%					
Responsivity (not 9bit, analog gain:off)	9DN/nj/cm ² (@8bit)	19DN/nj/cm ² (@8bit)	9DN/nj/cm ² (@8bit)	19DN/nj/cm ² (@8bit)	9DN/nj/cm ² (@8bit)	19DN/nj/cm ² (@8bit)
Responsivity (not 9bit, analog gain:on)	38DN/nj/cm ² (@8bit)	77DN/nj/cm ² (@8bit)	38DN/nj/cm ² (@8bit)	77DN/nj/cm ² (@8bit)	38DN/nj/cm ² (@8bit)	77DN/nj/cm ² (@8bit)
Responsivity (9bit, analog gain:off)	19DN/nj/cm ² (@8bit)	38DN/nj/cm ² (@8bit)	19DN/nj/cm ² (@8bit)	38DN/nj/cm ² (@8bit)	19DN/nj/cm ² (@8bit)	38DN/nj/cm ² (@8bit)
Responsivity (9bit, analog gain:on)	77DN/nj/cm ² (@8bit)	155DN/nj/cm ² (@8bit)	77DN/nj/cm ² (@8bit)	155DN/nj/cm ² (@8bit)	77DN/nj/cm ² (@8bit)	155DN/nj/cm ² (@8bit)

1.3 Mechanical Specifications

Model	FS-B16KU35CLU	FS-B8KU7CLU	FS-B8KU35CLU	FS-B4KU7CLU	FS-B4KU35CLU	FS-B2KU7CLU
Dimensions	80(W) x 100(H) x 38.1(D) mm (excluding the connector)		80(W) x 58(H) x 26.5(D) mm (excluding the connector)			
Lens mount	M42 mount P = 0.75mm	F, M42 mount	F mount	F mount	F,C mount	F,C mount
Weight	Approx. 453g		Approx. 250g			
Interface connectors	Camera Link connector (MDR) x1 Power connector (6pin connector)					

1.4 Environmental Specifications

Model	FS-B16KU35CLU	FS-B8KU7CLU	FS-B8KU35CLU	FS-B4KU7CLU	FS-B4KU35CLU	FS-B2KU7CLU
RoHS	RoHS Compliant					
Operating temperature	0 to 40 deg. C					
Storage temperature	-30 to 65 deg. C					

2. Product Numbering Method

FS - B 8K U7 D CL U - M72
 (1) (2) (3) (4) (5) (6) (7) (8)

(1) Series

(2) BW / Color

B: Black and White

C: Color

(3) Number of pixels

16: 16K

8: 8K

4: 4K

2: 2K

(4) Pixel Size

U14: 14um

U35: 35um

U7: 7um

(5) Line Number

None: 1 line (single)

D: 2 lines (dual)

Q: 4 lines (Quad)

(6) Output type

CL: Camera link

GE: GigE Vision

(7) Software type

Non: ASCII communication

U: Field Update type(Binary communication)

(8) Mount type

C: C Mount

F: F Mount

M42: M42 Mount

M72: M72 Mount

2.1 Order Number

Model Number	Description
FS-B16KU35CLU-M72	B&W 16K Single line Camera Link 3.5umx3.5um M72-Mount
FS-B8KU7CLU-M72	B&W 8K Single line Camera Link 7umx7um M72-Mount
FS-B8KU35CLU-F	B&W 8K Single line Camera Link 3.5umx3.5um F-Mount
FS-B4KU7CLU-F	B&W 4K Single line Camera Link 7umx7um F-Mount
FS-B4KU7CLU-M42	B&W 4K Single line Camera Link 7umx7um M42-Mount
FS-B4KU35CLU-F	B&W 4K Single line Camera Link 3.5umx3.5um F-Mount
FS-B4KU35CLU-C	B&W 4K Single line Camera Link 3.5umx3.5um C-Mount
FS-B4KU35CLU-M42	B&W 4K Single line Camera Link 3.5umx3.5um M42-Mount
FS-B2KU7CLU-F	B&W 2K Single line Camera Link 7umx7um F-Mount
FS-B2KU7CLU-C	B&W 2K Single line Camera Link 7umx7um C-Mount
FS-B2KU7CLU-M42	B&W 2K Single line Camera Link 7umx7um M42-Mount

3. Connector Specifications

3.1 FS-B2KU7CLU

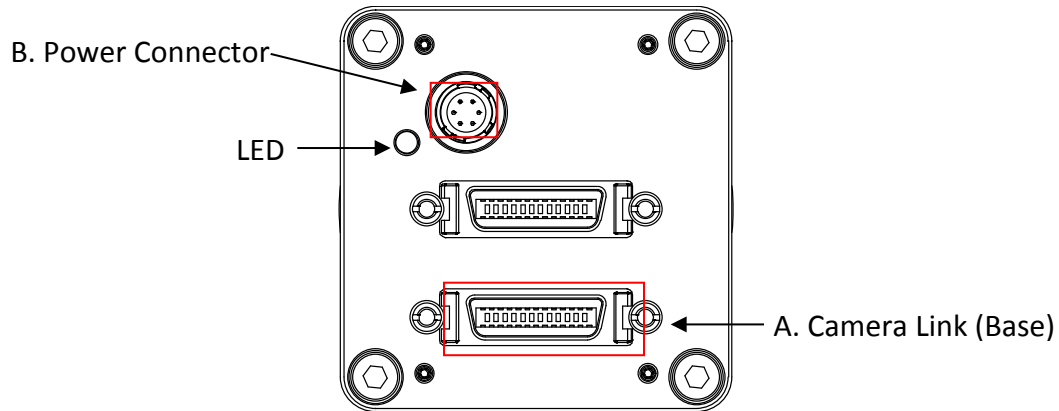

A. Camera Link connector (Base): MDR Receptacle (3M)

B. Power connector: HR10A-7R-6PB (Hirose or equivalent)

This connector is for +12 Vdc to +24Vdc power input.

When the camera is powered on, the LED will be lit Red.

3.2 FS-B2KU35CLU, FS-B4KU7DCLU, FS-B4KU35CLU

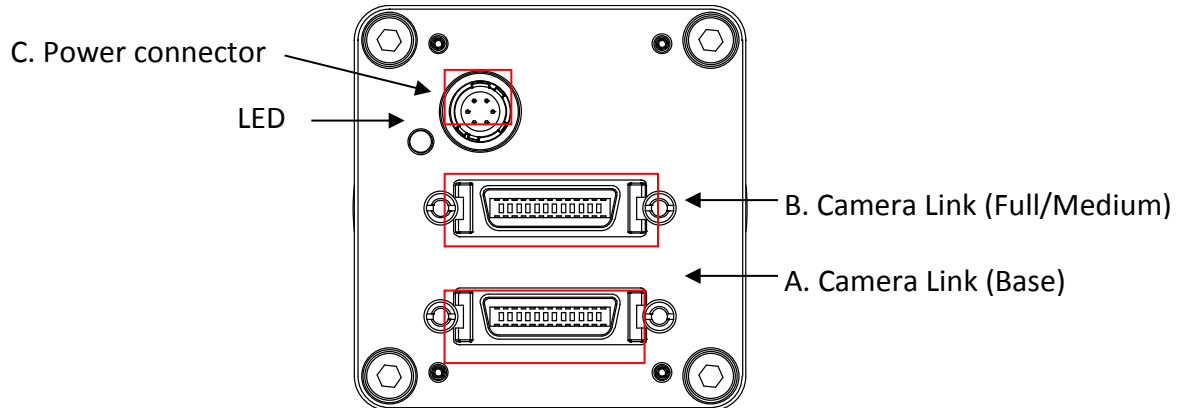

- A. Camera Link connector (Base): MDR Receptacle (3M)
- B. Camera Link connector (Full/Medium): MDR Receptacle (3M)
- C. Power connector: HR10A-7R-6PB (Hirose or equivalent)
This connector is for +12Vdc to +24Vdc power input.
When the camera is powered on, the LED will be lit Red.

3.3 FS-B8KU7CLU, FS-B16KU35CLU

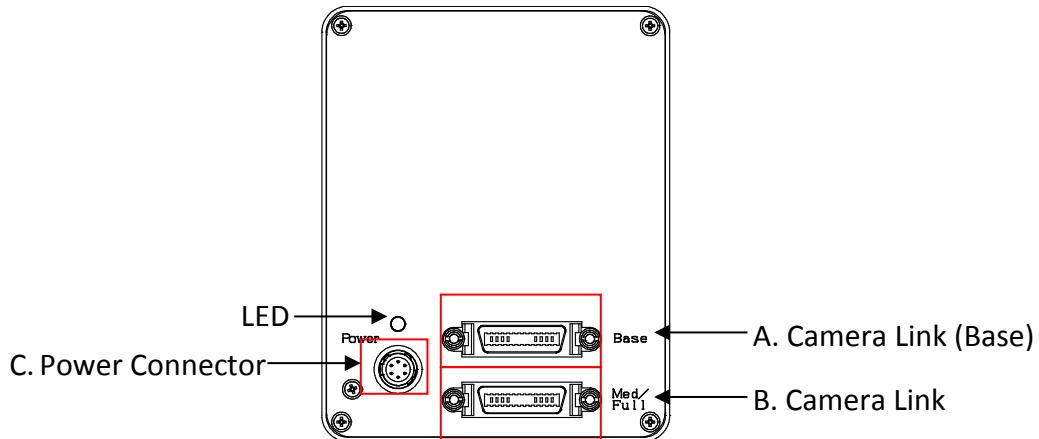

- A. Camera Link connector (Base): MDR Receptacle (3M)
- B. Camera Link connector (Full/Medium): MDR Receptacle (3M)
- C. Power connector: HR10A-7R-6PB (Hirose or equivalent)
This connector is for +12Vdc to +24Vdc power input.
When the camera is powered on, the LED will be lit Red.

3.4 Pin Assignment of the Connectors

A. Camera Link Connector (Base): MDR Receptacle (3M)

Pin No.	Signal name	Pin No.	Signal name
1	GND	14	GND
2	X0-	15	X0+
3	X1-	16	X1+
4	X2-	17	X2+
5	Xclk-	18	Xclk+
6	X3-	19	X3+
7	SerTC+	20	SerTC-
8	SerTFG-	21	SerTFG+
9	CC1- (for the external sync signal input)	22	CC1+ (for the external sync signal input)
10	CC2+	23	CC2-
11	CC3-	24	CC3+
12	CC4+	25	CC4-
13	GND	26	GND

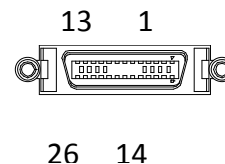

B. Camera Link Connector (Medium): MDR Receptacle (3M)

Pin No.	Signal name	Pin No.	Signal name
1	GND	14	GND
2	Y0-	15	Y0+
3	Y1-	16	Y1+
4	Y2-	17	Y2+
5	Yclk-	18	Yclk+
6	Y3-	19	Y3+
7	100 Ohm terminated	20	100 Ohm terminated
8	Z0-	21	Z0+
9	Z1-	22	Z1+
10	Z2-	23	Z2+
11	Zclk-	24	Zclk+
12	Z3-	25	Z3+
13	GND	26	GND

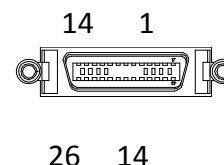

signal name	I/O	explanation
CC1	I	Ext TRG. Refer to section 5.
CC2	-	Spare
CC3	-	Spare
CC4	-	Spare
SerTC	I	Serial communication from the frame grabber.
SerTFG	O	Serial communication to the frame grabber.

C. Power Connector: HR10A-7R-6PB (Hirose or equivalent) (Cable connector: HR10A-7P-6S or equivalent)

Pin No.	Signal name	IN/OUT	Voltage
1	+12 V	IN	+12 V
2	+12 V	IN	+12 V
3	+12 V	IN	+12 V
4	GND		
5	GND		
6	GND		

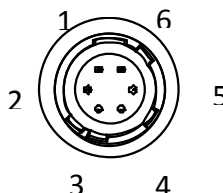

3.5 Bit Assignment

3.5.1 Full Configuration

Base connector			
Port/bit	8-bit x 8	Port/bit	8-bit x8
Port A0	A0	Port C0	C0
Port A1	A1	Port C1	C1
Port A2	A2	Port C2	C2
Port A3	A3	Port C3	C3
Port A4	A4	Port C4	C4
Port A5	A5	Port C5	C5
Port A6	A6	Port C6	C6
Port A7	A7	Port C7	C7
Port B0	B0		
Port B1	B1		
Port B2	B2		
Port B3	B3		
Port B4	B4		
Port B5	B5		
Port B6	B6		
Port B7	B7		

Full connector					
Port/bit	8-bit x 8	Port/bit	8-bit x8	Port/bit	8-bit x8
Port D0	D0	Port F0	F0	Port H0	H0
Port D1	D1	Port F1	F1	Port H1	H1
Port D2	D2	Port F2	F2	Port H2	H2
Port D3	D3	Port F3	F3	Port H3	H3
Port D4	D4	Port F4	F4	Port H4	H4
Port D5	D5	Port F5	F5	Port H5	H5
Port D6	D6	Port F6	F6	Port H6	H6
Port D7	D7	Port F7	F7	Port H7	H7
Port E0	E0	Port G0	G0		
Port E1	E1	Port G1	G1		
Port E2	E2	Port G2	G2		
Port E3	E3	Port G3	G3		
Port E4	E4	Port G4	G4		
Port E5	E5	Port G5	G5		
Port E6	E6	Port G6	G6		
Port E7	E7	Port G7	G7		

3.5.2 Medium Configuration

10bit Mode

Base connector			
Port/bit	10-bit x 4taps	Port/bit	10-bit x 4taps
Port A0	A0	Port C0	B0
Port A1	A1	Port C1	B1
Port A2	A2	Port C2	B2
Port A3	A3	Port C3	B3
Port A4	A4	Port C4	B4
Port A5	A5	Port C5	B5
Port A6	A6	Port C6	B6
Port A7	A7	Port C7	B7
Port B0	A8		
Port B1	A9		
Port B2	nc		
Port B3	nc		
Port B4	B8		
Port B5	B9		
Port B6	nc		
Port B7	nc		

Medium connector			
Port/bit	10-bit x 4taps	Port/bit	10-bit x 4taps
Port D0	D0	Port F0	C8
Port D1	D1	Port F1	C9
Port D2	D2	Port F2	nc
Port D3	D3	Port F3	nc
Port D4	D4	Port F4	D8
Port D5	D5	Port F5	D9
Port D6	D6	Port F6	nc
Port D7	D7	Port F7	nc
Port E0	C0		
Port E1	C1		
Port E2	C2		
Port E3	C3		
Port E4	C4		
Port E5	C5		
Port E6	C6		
Port E7	C7		

8bit Mode

Base connector			
Port/bit	8-bit x 4taps	Port/bit	8-bit x 4taps
Port A0	A0	Port C0	C0
Port A1	A1	Port C1	C1
Port A2	A2	Port C2	C2
Port A3	A3	Port C3	C3
Port A4	A4	Port C4	C4
Port A5	A5	Port C5	C5
Port A6	A6	Port C6	C6
Port A7	A7	Port C7	C7
Port B0	B0		
Port B1	B1		
Port B2	B2		
Port B3	B3		
Port B4	B4		
Port B5	B5		
Port B6	B6		
Port B7	B7		

Medium connector			
Port/bit	8-bit x 4taps	Port/bit	8-bit x 4taps
Port D0	D0	Port F0	nc
Port D1	D1	Port F1	nc
Port D2	D2	Port F2	nc
Port D3	D3	Port F3	nc
Port D4	D4	Port F4	nc
Port D5	D5	Port F5	nc
Port D6	D6	Port F6	nc
Port D7	D7	Port F7	nc
Port E0	nc		
Port E1	nc		
Port E2	nc		
Port E3	nc		
Port E4	nc		
Port E5	nc		
Port E6	nc		
Port E7	nc		

3.5.3 Base Configuration

10bit Mode

Base connector			
Port/bit	10-bit x 2taps	Port/bit	10-bit x 2taps
Port A0	A0	Port C0	B0
Port A1	A1	Port C1	B1
Port A2	A2	Port C2	B2
Port A3	A3	Port C3	B3
Port A4	A4	Port C4	B4
Port A5	A5	Port C5	B5
Port A6	A6	Port C6	B6
Port A7	A7	Port C7	B7
Port B0	A8		
Port B1	A9		
Port B2	nc		
Port B3	nc		
Port B4	B8		
Port B5	B9		
Port B6	nc		
Port B7	nc		

8bit Mode

Base connector			
Port/bit	8-bit x 2taps	Port/bit	8-bit x 2taps
Port A0	A0	Port C0	nc
Port A1	A1	Port C1	nc
Port A2	A2	Port C2	nc
Port A3	A3	Port C3	nc
Port A4	A4	Port C4	nc
Port A5	A5	Port C5	nc
Port A6	A6	Port C6	nc
Port A7	A7	Port C7	nc
Port B0	B0		
Port B1	B1		
Port B2	B2		
Port B3	B3		
Port B4	B4		
Port B5	B5		
Port B6	B6		
Port B7	B7		

4 Timing Chart

4.1 Exposure Time

EXT_LINE

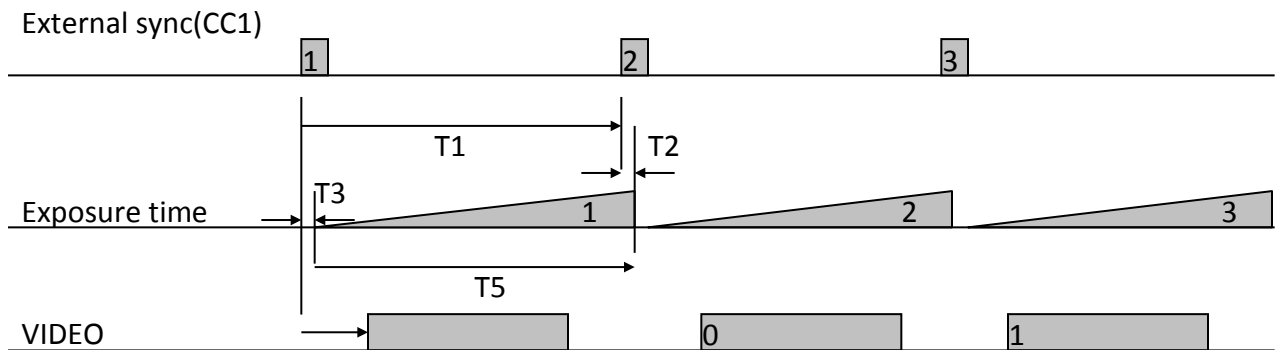

EXT_FIX MODE

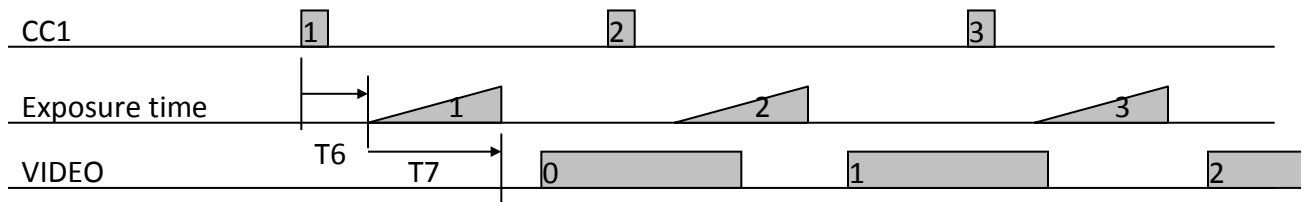

PULSE MODE

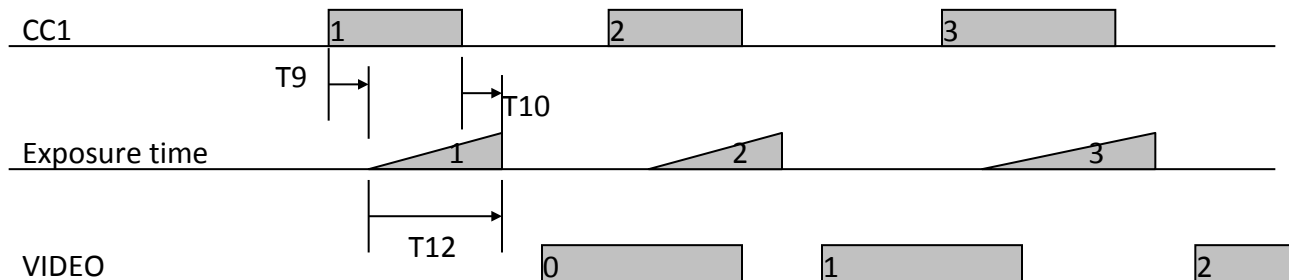

INTERNAL MODE

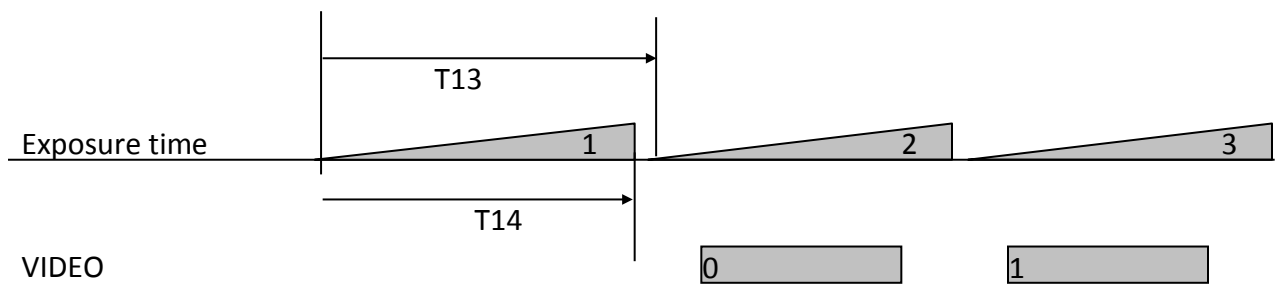

Label	Description	Value [us]
T1	Line interval	External sync : CC1 line period
T2	Sync rise to exposure end	$(6 \times B) + 1$
T3	Sync rise to exposure start	B16K : $(18 \times B) + 4$ Except B16K: $(18 \times B) + 1$
T5	Exposure time(EXT_LINE)	B16K : $T1 - (12 \times B) - 3$ Except B16K : $T1 - (12 \times B) - 2$
T6	CC1 rise to exposure start (EXT_FIX)	$(6 \times B) + 2$
T7	Exposure time (EXT_FIX)	External Sync Fix Exposure : Exposure Time [us]:Exposure time setting value*C+2
T9	CC1 rise to exposure start PULSE)	$(5 \times B) + 2$
T10	CC1 fall to exposure end PULSE)	$(5 \times B) + 1$
T12	Exposure time (PULSE)	External Sync Pulse Exposure : Exposure Time [us]:Pulse Width of CC1-1
T13	Line interval (INTERNAL)	Line Cycle [us]: (Exposure time setting value *C)+A A : Minimum line period
T14	Exposure time (INTERNAL)	Exposure Time [us]: (Exposure time setting value *C)+A-(2+12*B)

Note: For further information on parameters A, B, & C please refer to the corresponding sections below.

Minimum and Maximum Pulse Width on T12 are shown below.

Minimum Pulse Width = 3us, Maximum Pulse Width = Line Interval – 2us

A. Minimum Line Period [us]

Output mode(Eeh)	FS-B16KU35CLU	FS-B8KU35CLU, FS-B8KU7CLU	FS-B4KU7CLU, FS-B4KU35CLU	FS-B2KU7CLU
0	25.4 us	13.2 us	13.2 us	13.2 us
1	41.6 us	21.1 us	21.1 us	21.1 us
2	48.6 us	24.5 us	24.5 us	-
3	82.6 us	41.6 us	41.6 us	-
4	96.8 us	48.6 us	-	-
5	164.5 us	82.6 us	-	-
8	26 us	13.2 us	13.2 us	13.2 us
9	51.6 us	25 us	25 us	-
10	102.8 us	51.6 us	-	-
11	25 us	12.5 us	12.5 us	12.5 us
23	-	13.2 us	13.2 us	-
24	-	13.2 us	13.2 us	-
25	-	21.1 us	21.1 us	-
26	25.4 us	13.2 us	13.2 us	13.2 us
27	26 us	13.2 us	13.2 us	13.2 us
28	41.6 us	21.1 us	21.1 us	21.1 us

B. CLUK Period

Model	Value [us]
FS-B16KU35CLU	0.0235
Except for FS-B16KU35CLU	0.0117

C. Amount of Change Time per Step

Model	Value [us]
FS-B16KU35CLU	0.4
Except for FS-B16KU35CLU	0.2

5 Output Format

5.1 FS-B2KU7CLU

Selectable output modes are listed in the table below.

The video output can be selected through the register access (EEh).

Output mode(EEh)	Mode	Data rate	Configuration	Maximum line rate	Sensor mode
0	2tap	85MHz x 2tap	Base	75kHz	
1	2tap	50MHz x 2tap	Base	47kHz	
8	2tap	80MHz x 2tap	Base	75kHz	
11	2tap / 9bit	85MHz x 2tap	Base	80kHz	9bit
26	AOI 2tap	85MHz x 2tap	Base	75kHz	
27	AOI 2tap	80MHz x 2tap	Base	75kHz	
28	AOI 2tap	50MHz x 2tap	Base	47kHz	

5.1.1 Video Output format Timing Chart (Base Configuration)

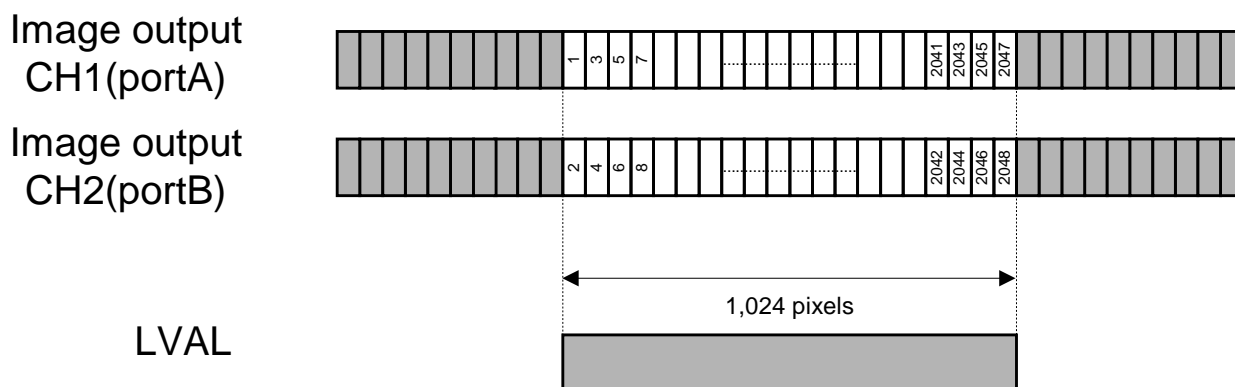

5.1.2 Video Output format Timing Chart "AOI Mode" (Base Configuration)

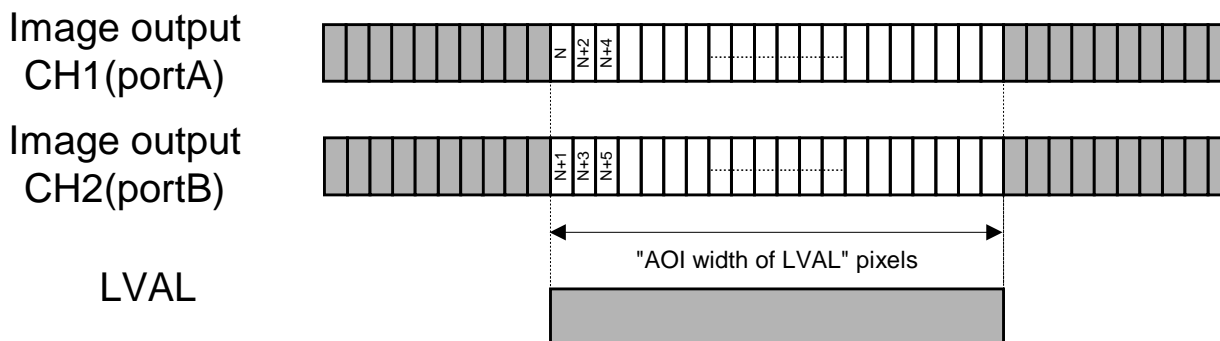

$$N = [\text{AOI Width}] * 2 + 1$$

[AOI Width]: User Selected

5.2 FS-B4KU35CLU, FS-B4K7CLU

Selectable output modes are listed in the table below.

Video Output format can be selected through the register access (EEh).

Output mode(EEh)	Mode	Data rate	Configuration	Maximum line rate	Sensor mode
0	4tap	85MHz x 4tap	Medium	75kHz	
1	4tap	50MHz x 4tap	Medium	47kHz	
2	2tap	85MHz x 2tap	Base	40kHz	
3	2tap	50MHz x 2tap	Base	24kHz	
8	4tap	80MHz x 4tap	Medium	75kHz	
9	2tap	80MHz x 2tap	Base	38kHz	
11	4tap / 9bit	85MHz x 4tap	Medium	80kHz	9bit
26	AOI 2tap	85MHz x 2tap	Base	75kHz	
27	AOI 2tap	80MHz x 2tap	Base	75kHz	
28	AOI 2tap	50MHz x 2tap	Base	47kHz	

5.2.1 Video Output format Timing Chart (Medium Configuration)

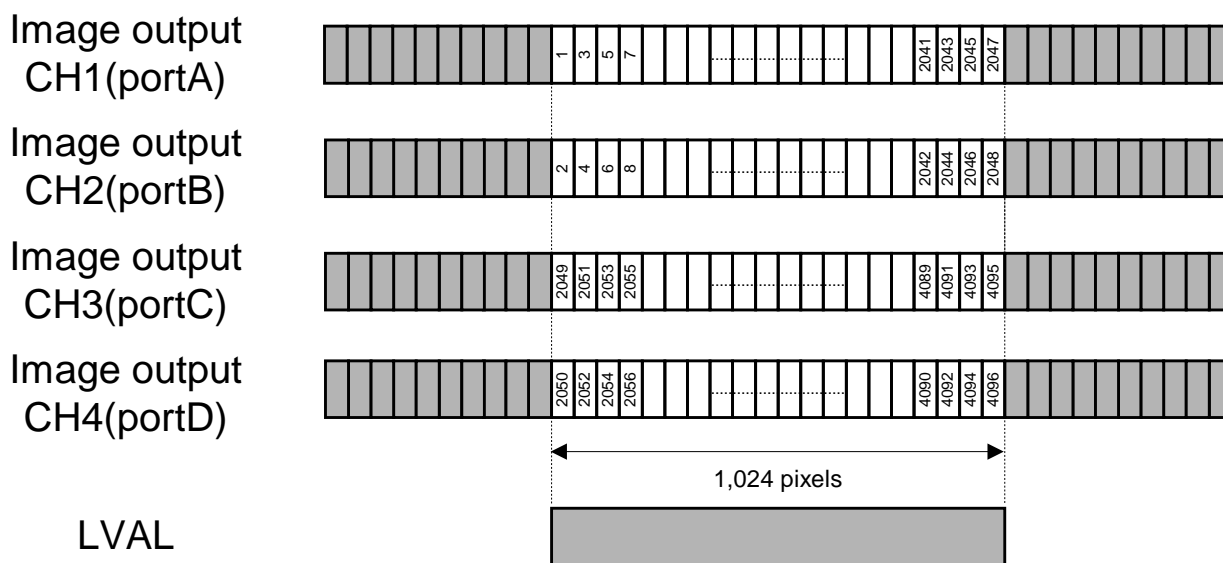

5.2.2 Video Output format Timing chart (Base Configuration)

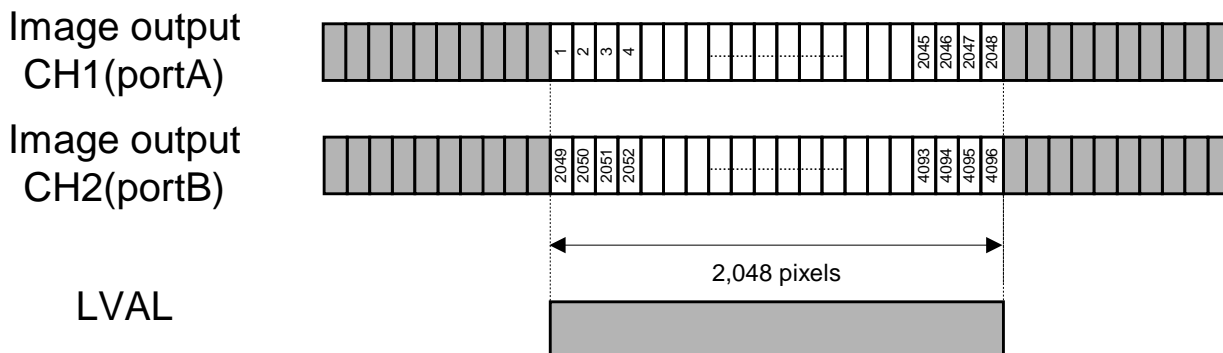

5.2.3 Video Output format Timing chart "AOI Mode" (Base Configuration)

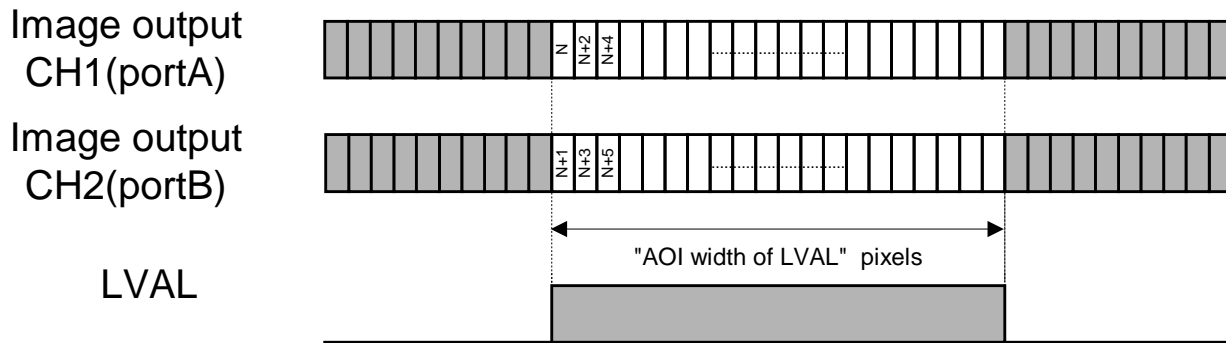

$$N = [\text{AOI Width}] * 2 + 1$$

[AOI Width]: User Selected

5.3 FS-B8KU35CLU, FS-B8KU7CLU

Selectable output modes are listed in the table below.

Video Output format can be selected through the register access (EEh).

Output mode(EEh)	Mode	Data rate	Configuration	Maximum line rate	Sensor mode
0	8tap	85MHz x 8tap	Full	75kHz	
1	8tap	50MHz x 8tap	Full	47kHz	
2	4tap	85MHz x 4tap	Medium	40kHz	
3	4tap	50MHz x 4tap	Medium	24kHz	
4	2tap	85MHz x 2tap	Base	20kHz	
5	2tap	50MHz x 2tap	Base	12kHz	
8	8tap	80MHz x 8tap	Full	75kHz	
9	4tap	80MHz x 4tap	Medium	38kHz	
10	2tap	80MHz x 2tap	Base	19kHz	
11	8tap / 9bit	85MHz x 8tap	Full	80kHz	9bit
23	AOI Parallel 8tap	85MHz x 8tap	Full	75kHz	
24	AOI Parallel 8tap	80MHz x 8tap	Full	75kHz	
25	AOI Parallel 8tap	50MHz x 8tap	Full	47kHz	
26	AOI 2tap	85MHz x 2tap	Base	75kHz	
27	AOI 2tap	80MHz x 2tap	Base	75kHz	
28	AOI 2tap	50MHz x 2tap	Base	47kHz	

5.3.1 Video Output format Timing Chart (Full Configuration)

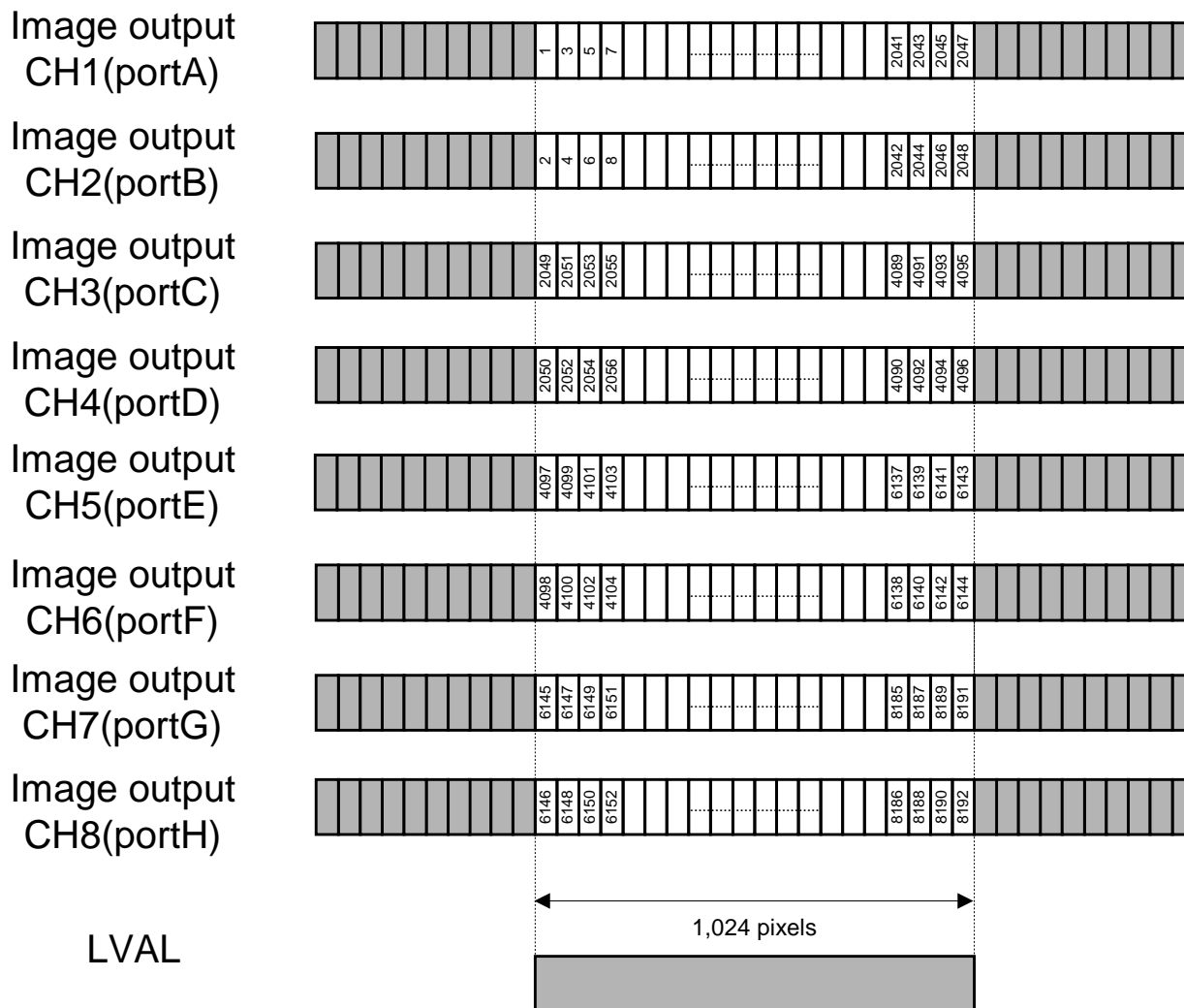

5.3.2 Video Output format Timing Chart (Medium Configuration)

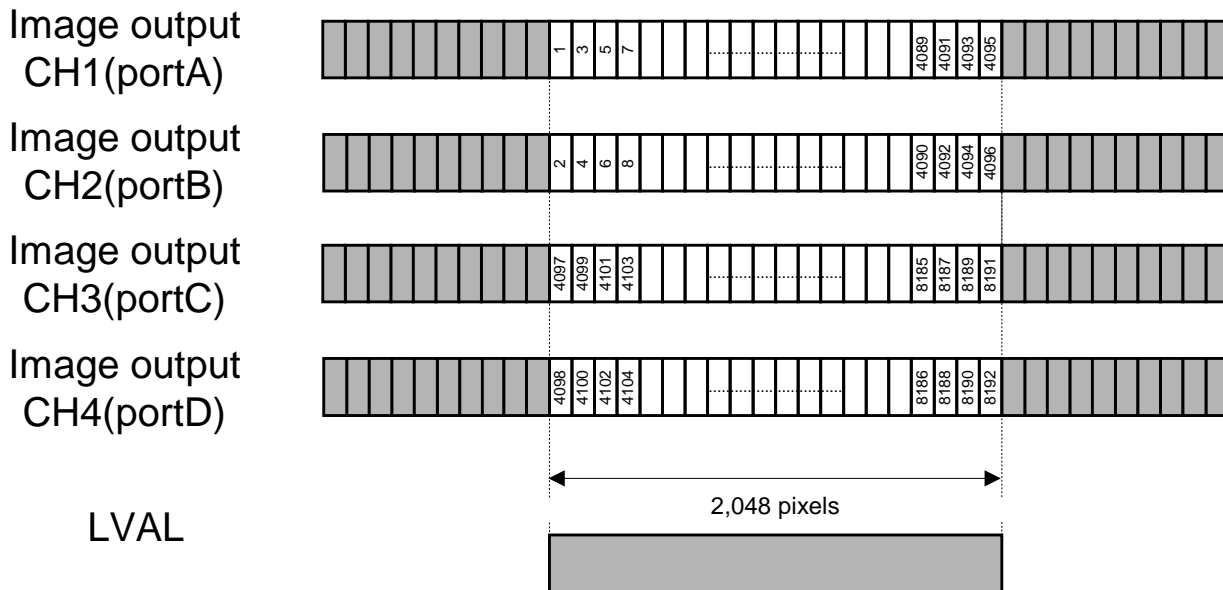

5.3.3 Video Output format Timing Chart (Base Configuration)

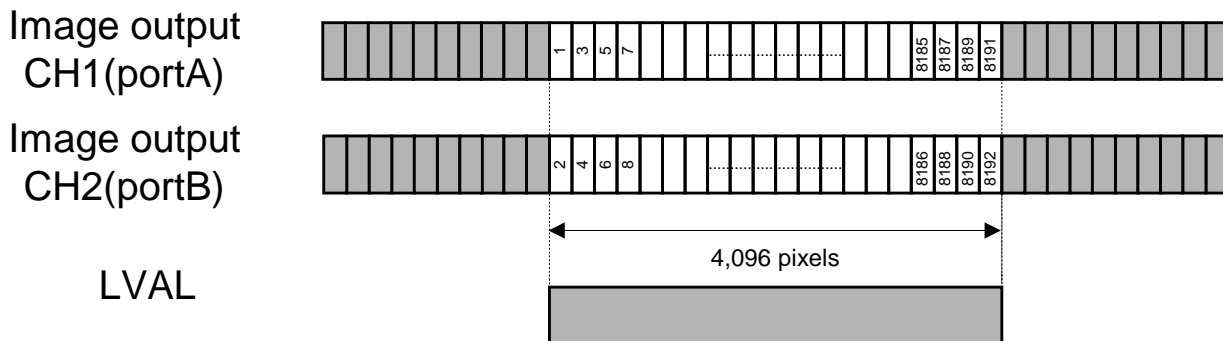

5.3.4 Video Output format Timing Chart "AOI Mode" (Base Configuration)

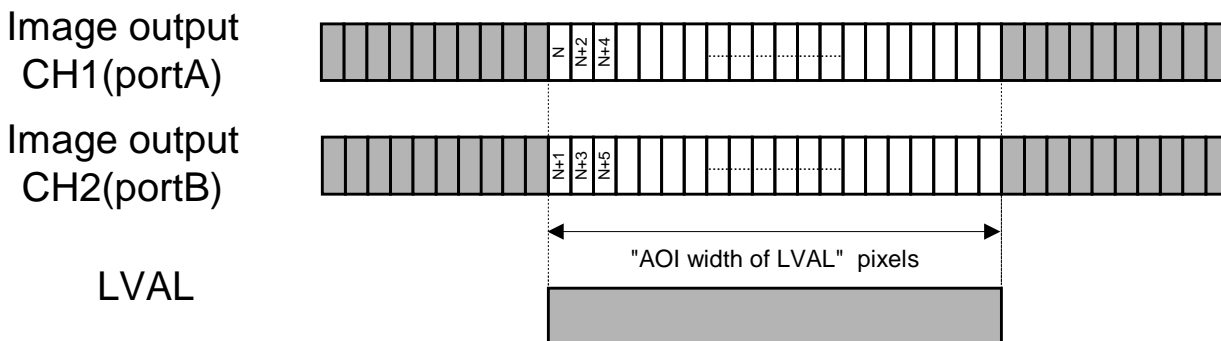

$N = [\text{AOI Width}] * 2 + 1$
 [AOI Width]: User Selected

5.3.5 Video Output format Timing Chart “AOI Mode” (Full Configuration)

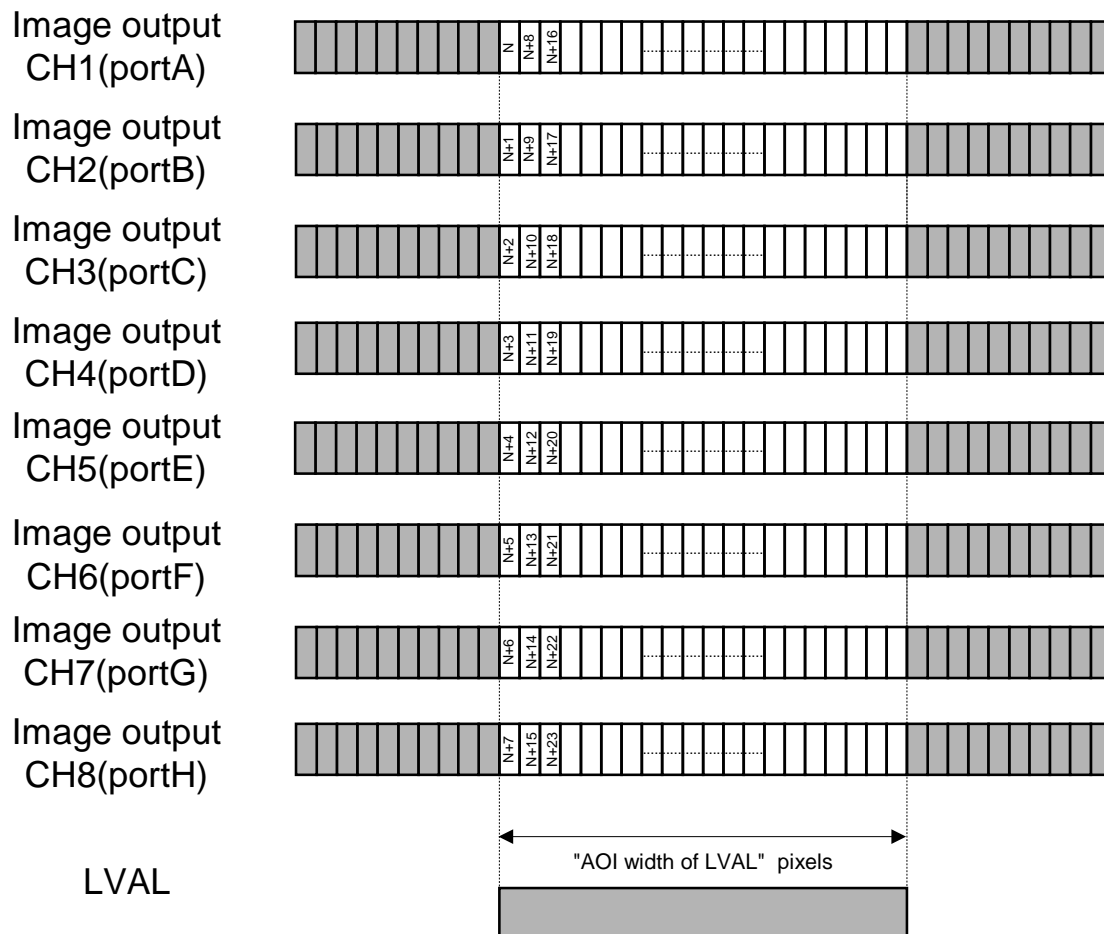

$N = [\text{AOI Width}] * 2 + 1$
 [AOI Width]: User Selected

5.4 FS-B16KU35CLU

Selectable Output Modes are listed in the table below.

Video output format can be selected through the register access (EEh).

Output mode(EEh)	Mode	Data rate	Configuration	Maximum line rate	Sensor mode
0	8tap	85MHz x 8tap	Full	39kHz	
1	8tap	50MHz x 8tap	Full	24kHz	
2	4tap	85MHz x 4tap	Medium	20kHz	
3	4tap	50MHz x 4tap	Medium	12kHz	
4	2tap	85MHz x 2tap	Base	10kHz	
5	2tap	50MHz x 2tap	Base	6kHz	
8	8tap	80MHz x 8tap	Full	38kHz	
9	4tap	80MHz x 4tap	Medium	19kHz	
10	2tap	80MHz x 2tap	Base	9kHz	
11	8tap / 9bit	85MHz x 8tap	Full	40kHz	9bit
26	AOI 2tap	85MHz x 2tap	Base	39kHz	
27	AOI 2tap	80MHz x 2tap	Base	38kHz	
28	AOI 2tap	50MHz x 2tap	Base	24kHz	

5.4.1 Video Output format Timing Chart (Full Configuration)

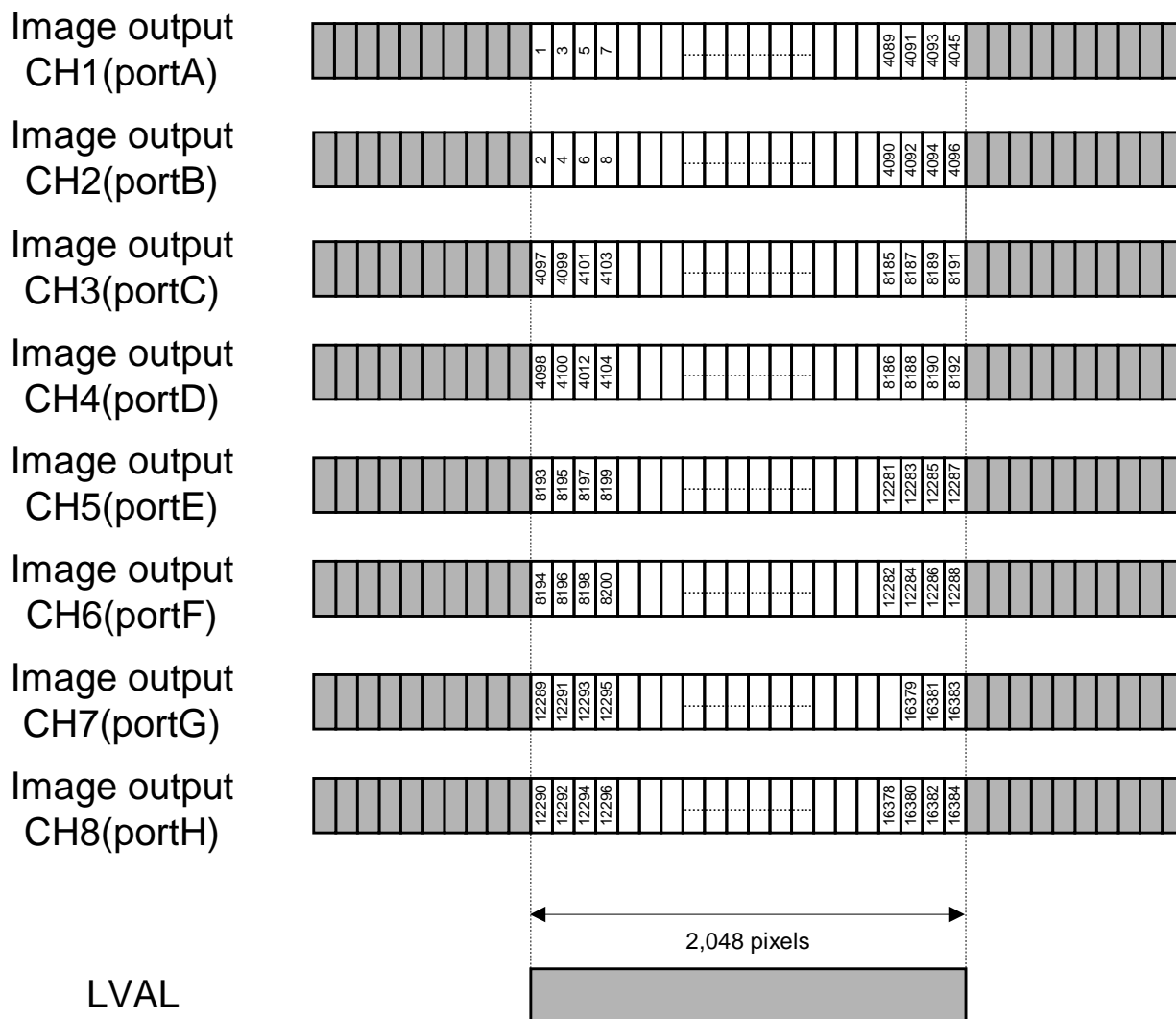

5.4.2 Video Output Format Timing Chart (Medium Configuration)

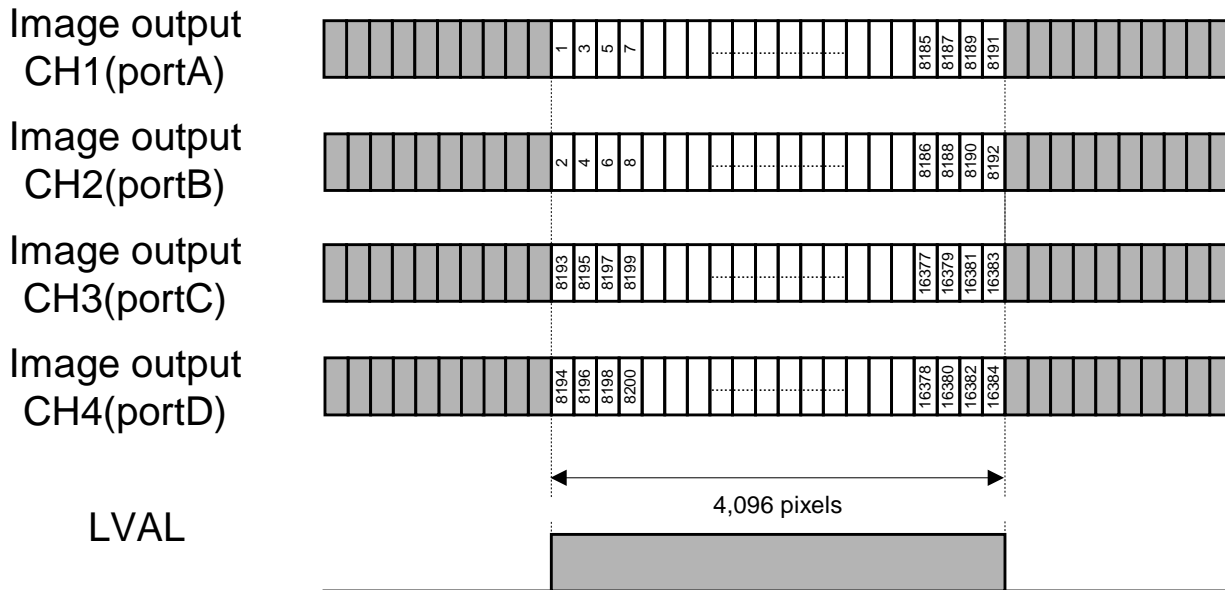

5.4.3 Video Output Format Timing Chart (Base Configuration)

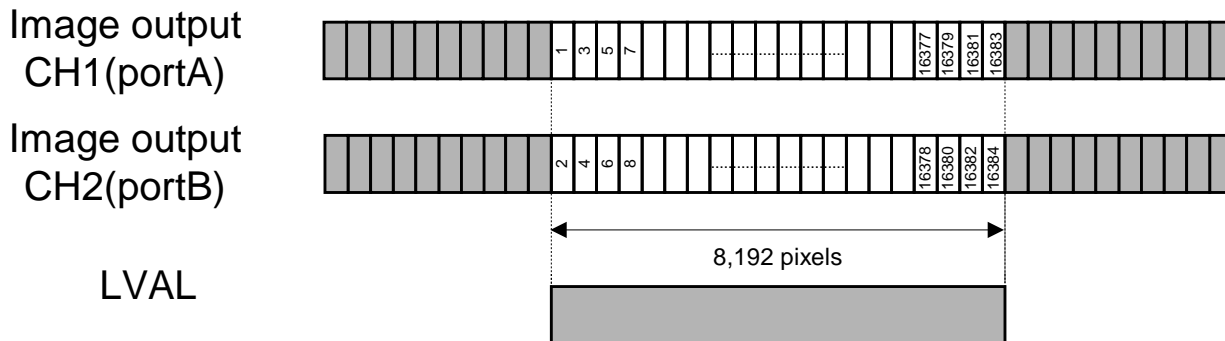

5.4.4 Video Output Format Timing Chart "AOI Mode" (Base Configuration)

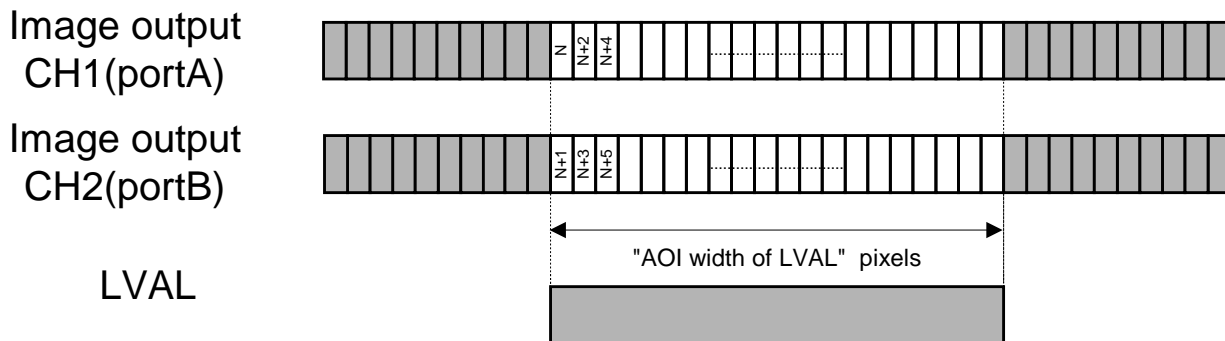

$N = [\text{AOI Width}] * 2 + 1$
 [AOI Width]: User Selected

6. Details of Camera Control

6.1 Field Flat Correction (FFC)

Field Flat Correction (FFC) is used for correcting non-uniformity image brightness caused by the lens of the imager. When using this camera, FFC should be used to help correct fixed pattern noise on the imager.

6.1.1 Summary of FFC

When using FFC, the gain and offset are added to each pixel. Adding the gain helps to flatten the gray video level and adding the offset helps to flatten the Shield Light Level. The concept FFC is shown on the chart below.

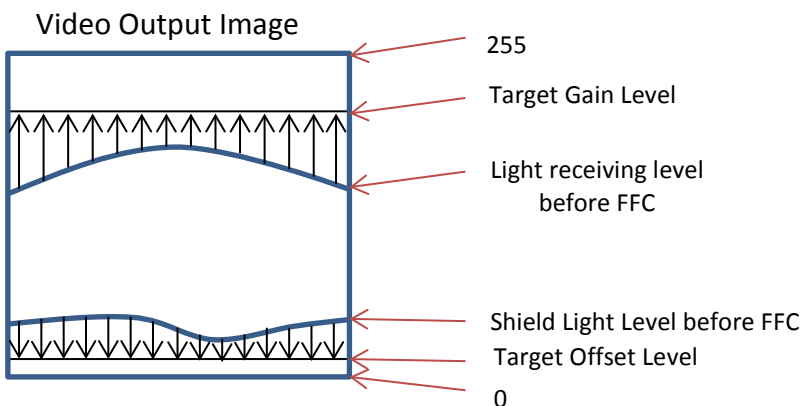

Gain and offset value for each pixel can set through the Auto Mode and Manual mode.

6.1.2 Technical Terminology

[AAh: B]

Please set the value on the address as below through the communication protocol.

AA: Register address (Hex)

B: Value (Dec)

6.1.3 Auto FFC Procedure

After the target gain and offset levels have been set, the camera will correct the gain and offset value automatically under the calibration setting.

The user has to set the FFC under their personal conditions. If the wrong procedure is executed, the correction can be recovered from the beginning.

[Procedure]

- 1) Set the OFF on [FFC Mode] [81h: 0]
(This register is the trigger at 4)
- 2) Set the value on [Target FFC Offset] [8Ah: 5]
(Set the offset value (range: 0 to 255, recommended: 5))
- 3) Shield the light.
- 4) Set the Auto(offset) on [FFC Mode] [81h: 6]

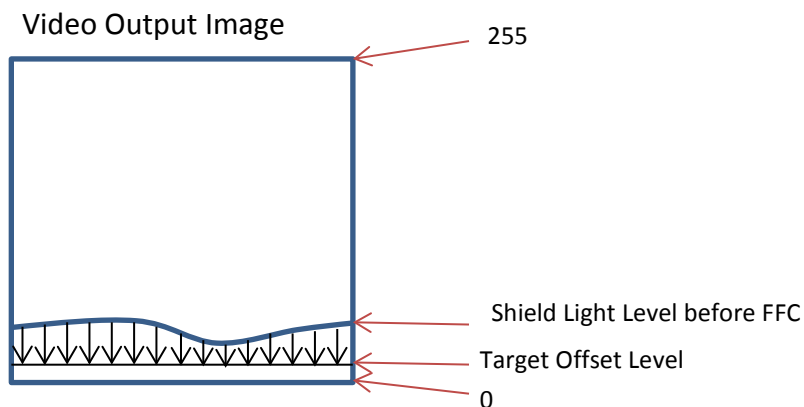

- 5) Set the ON (only Offset) on [FFC Mode] [81h: 7]
(This setting is necessary to determine the target level for checking the actual video image at the next step.)
- 6) Un-Cover the sensor
Please do not saturate the image.
Focus the camera on a smooth white clean object for calibration and set the parameters to the actual condition.

Note:

If the case is "Auto Target" → jump to step 11

Auto Target is the function that sets the target gain level automatically.

The formula Target gain level = Maximum light receiving level + α is used to determine the target gain level.

If the case is "Fixed Target Level" → continue to step 7

7) Set [Target FFC Gain] level [88h: 200]

Configurable range is 0 to 255.

The value should be ten steps larger than the brightest level on the video image.

A brighter video value than the target gain level outputs the data without correction.

Initial [Target FFC Gain] level is 200. User can adjust this level with actual video image.

8) Set the Auto (Gain) on [FFC Mode] [81h: 5]

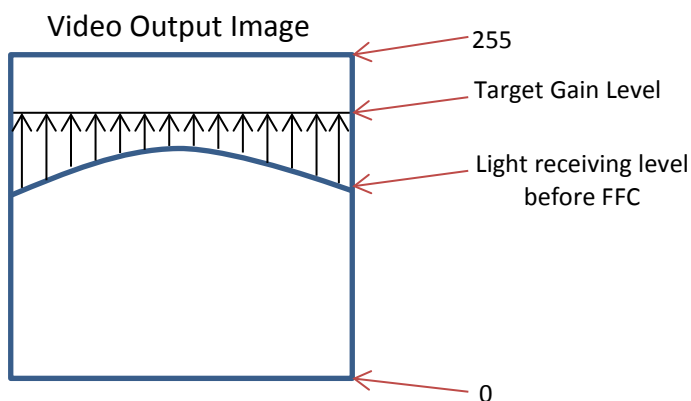

9) Confirm the FFC Function

Set the ON (Gain + Offset) on [FFC Mode] [81h: 1]

10) Check the Saturation Level

The Saturation Level should be set to 255.

Please extend the exposure time, increase the light, or open the IRIS.

If un-saturated (less than 255) exist, please set the [Target FFC Gain] [88h:] again. This value should be larger than the previous value.

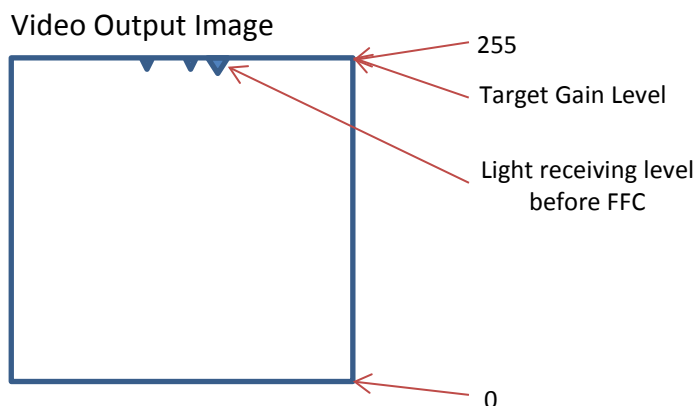

If the user is utilizing FFC Setting (Auto) this is the end of the process.

If the user is using “Auto Target”, please continue in the following steps.

11) Set the Target Offset level for gain [88h: recommendation 20]

Set the value from the range 0 to 255 (8bit)

To determine the target level automatically, offset level has to be set.

(Target level should be the same value of this Target offset level plus highest point of light receiving level)

12) Set the Auto of FFC Mode (Gain) (Auto Offset) [81h: 8]

Gain correction works automatically.

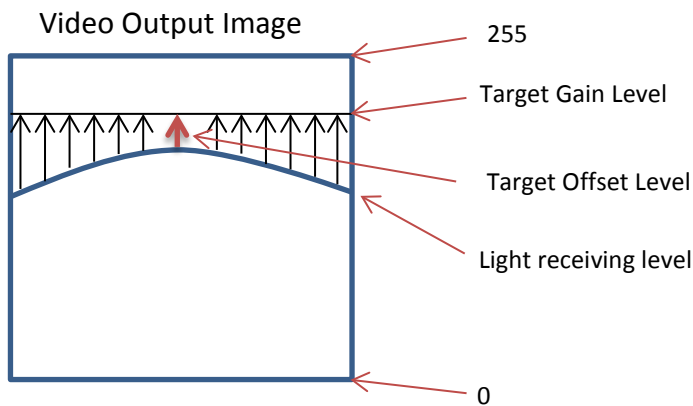

6.1.4 Manual FFC Procedure

The Manual [FFC Mode] can correct specific pixel addresses and correct all pixels of the same value. When dust creates a gap in the calibration object after Auto on [FFC Mode], the user can revise the value of the specific pixel address.

[Procedure (by Pixel)]

- 1) Set the Manual (all pixels) on [FFC Mode] [81h: 3]
- 2) Set the Select FFC (Gain, Offset) to determine the output gain or offset [82h: 1 or 2]
- 3) Set the pixel address on [FFC Address] [86-87h:]
- 4) Set the FFC Value on [FFC Data] [84-85h:]
- 5) Set the "1" on [Set FFC] to reflect the setting on the camera [E1h: 4: 1]

[Procedure (all Pixels)]

- 1) Set the Manual (all pixels) on [FFC Mode] [81h: 4]
- 2) Set the Select FFC (Gain, Offset) to determine the output gain or offset [82h: 1 or 2]
- 3) Set the FFC value on [FFC Data] [84-85h]
- 4) Set the "1" on [Set FFC] to reflect the setting on the camera [E1h.4: 1]

6.1.5 Confirm FFC

FFC value (Gain / Offset) can be confirmed for each pixel as the video output data.

[Procedure]

- 1) Set the FFC value on [FFC Mode] [81h: 2]
- 2) Set the Select FFC (Gain, Offset) to determine the output gain or offset [82h: 1 or 2]
- 3) Set the [FFC Corrected Value Output] to determine the outputs lower or upper byte [83h:]

6.1.6 Save FFC

[FFC Data] can be saved on the EEPROM / FLASH memory. Once the data has been saved to the EEPROM / FLASH memory, FFC values will remain after turning off the camera.

Save FFC [E1h.6: 1]

Load FFC [E1h.7: 1]

6.1.7 FFC Corrected Value Store Mode

FFC is required to erase the fixed pattern noise from the image sensor. Twelve FFC corrected value can be stored.

		8Ch	EEh	8Dh	Load Camera Setting	Save Camera Setting	Camera turn on
Area0	Factory Setting Area	-	11	-	E2h.3	Disable	Data may not be loaded
Area1		-	excpet11	-			
Area2	User Default Access Area	0	11	-	E2h.1	E2h.0	Saved data on the EEPROM will be loaded automatically.
Area3		0	excpet11	-			
Area4	UserBANK Area(bank0)	1	-	0			
...			
Area11	UserBANK Area(bank7)	1	-	7			

Factory Setting Area:

FFC corrected values on the factory setting are stored in this area. (Factory Setting: No lens, with Lens Mount, Flat Light source)

The user cannot save data into this area.

Use Default Access Area:

The user can use this area to save and load the FFC corrected values on 8CH=0.

UserBANK Area:

The user can store corrected FFC data in this area. This area can be used to store settings under several different environments (e.g. different shutter, lighting, etc.)

When this area is used, please set the 8Ch=1 and select the UserBANK Area on 8Dh=0-7(Eight banks exist)

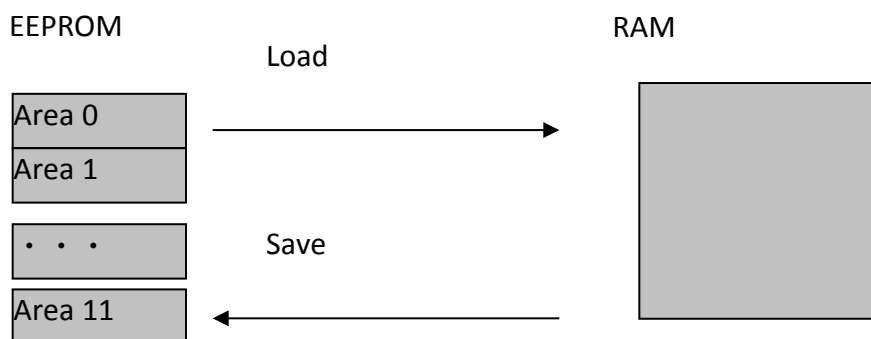

[Note]

*Only one RAM exists.

* When in use, the camera refers to the FFC corrected value on the RAM, EEPROM is used for storage.

*The reason Factory Setting Area and User Default Access Area have two areas:

The sensors characteristics are different on EEh=11 and another. FFC corrected values exist for each mode. FFC corrected values may be automatically loaded EEh is changed from EEh=11 to another or another to EEh=11 under 8Ch=0. If 8Ch=1 is used, the FFC corrected data will not be loaded automatically. The user has to control which setting (on EEh) should be stored on each bank.

7 Communication Protocol Specifications

The camera functions can be controlled via external devices such as PC. Please use the “CLCtrl” communication software or the following communication protocol to communicate to the camera.

7.1 Communication Method

UART (RS232C), Binary Communication

7.1.1 Communication Settings

	Settings
Baud rate	115,200bps
Data bit	8bit
Parity	None
Stop bit	1bit
Flow control	None

7.1.2 Communication Format

A. The format for sending data from the PC to the camera is as follows:

a. Send the Read command

SOF (8bit)	Device code (6bit)	Read (1bit)	Page selection (1bit)	Command code (8bit)	Data length (8bit)	Data (1byte)	EOF (8bit)
---------------	-----------------------	----------------	--------------------------	------------------------	-----------------------	-----------------	---------------

b. Send the Write Command

SOF (8bit)	Device code (6bit)	Write (1bit)	Page selection (1bit)	Command code (8bit)	Data length (8bit)	Data (Data length byte)	EOF (8bit)
---------------	-----------------------	-----------------	--------------------------	------------------------	-----------------------	----------------------------	---------------

B. The format for receiving data from the camera is as follows:

a. After the Read command has been sent

SOF (8bit)	Data length (8bit)	Data (Data length byte)	EOF (8bit)
---------------	-----------------------	----------------------------	---------------

b. After the Write command has been sent

SOF (8bit)	Data length (8bit) "00"	Receiving code (8bit)	EOF (8bit)
---------------	----------------------------	--------------------------	---------------

C. Descriptions of the Format

Name	Descriptions
SOF	Start of the frame Sets (or gets) the value is "02H" always.
Device code	Sets the device code of the camera is "000000".
Read / Write	Sets (or gets) "0" when the read command is sent. Sets (or gets) "1" when the write command is sent.
Page selection	Sets "0" when accessing the command register of the camera Gets current data from the command register when sent read command. The data of the command register is replaced by the sent data when sent write command. The data of the EEPROM is not replaced. Sets "1" when accessing the EEPROM of the camera The camera works with the data of the EEPROM when the camera is powered on. Gets the data from the EEPROM when sent read. The data of the EEPROM is replaced by sent data when sent write command. The camera sends the receiving code as "01H" to the PC after the data of the EEPROM is replaced. The camera rejects other commands while the data of the EEPROM is being replaced (approximately 5 msec. / byte).
Command code	Please refer from the following page.
Data length	Data length (Unit: byte) Receiving data The data length is dependent on the command after the read command is sent. The data length is "00H" after the write command is sent. Sending data The data length is 1 byte when the read command is sent. The data length is dependent on the command when the write command is sent.
Data	The value of the data is dependent on the command
EOF	End of the frame Sets (or gets) the value is "03H" always
Receiving code	Result of the sent command.

D. Example Commands

Send the Read command to Read the 00H address data of the register

02, 00, 00, 01, 00, 03

SOF, (Device code / Read / Register), Command Code, Data Length, Data, EOF

The Return Command:

02, 01, 00, 03

7.2 Camera Control Commands

7.2.1 Camera Control Command List

The underlined settings are factory default settings.

Command No. Bit No.	Command Description
00h	<p>【Camera Type】 Initial Data: Read Only To output the camera model.</p> <p>CBh:FS-B16KU35CLU C8h:FS-B8KU7CLU C7h:FS-B8KU35CLU C4h:FS-B4KU7CLU C3h:FS-B4KU35CLU C0h:FS-B2KU7CLU</p>

Command No. Bit No.	Command Description																											
10h.0-1	<p>【Exposure Mode】 Initial Data:0 To set the exposure mode.</p> <p>0:Line Exposure 1:Fix Exposure 2:Pulse Exposure 3:No function</p>	<p>There are 4 patterns through the combination of Exposure Mode and Sync Mode.</p> <table border="1"> <thead> <tr> <th colspan="2" rowspan="2"></th> <th colspan="2">Sync Mode</th> </tr> <tr> <th>1:External Sync</th> <th>2:Internal Sync</th> </tr> </thead> <tbody> <tr> <th rowspan="3">Exposure Mode</th> <th>0: <u>Line</u></th> <td>External Sync Line Exposure</td> <td rowspan="3">Internal Sync</td> </tr> <tr> <th>1: Fix</th> <td>External Sync Fix Exposure</td> </tr> <tr> <th>2: Pulse</th> <td>External Sync Pulse Exposure</td> </tr> </tbody> </table> <p>External Sync Line Exposure : Exposure Time[us]:Line Cycle-(2+(12*B))</p> <p>External Sync Fix Exposure : Exposure Time [us]:Exposure time setting value*C+2</p> <p>External Sync Pulse Exposure : Exposure Time [us]:Pulse Width of CC1-1</p> <p>Internal Sync : Exposure Time [us]: (Exposure time setting value *C)+A-(2+12*B) Line Cycle [us]: (Exposure time setting value *C)+A</p> <p>[Parameter] A:It depends on output mode B:CLK Cycle</p> <table border="1"> <thead> <tr> <th></th> <th>[us]</th> </tr> </thead> <tbody> <tr> <td>FS-B8KU7DCLU</td> <td>0.0235</td> </tr> <tr> <td>FS-B4KU7DCLU,FS-B2KU7DCLU</td> <td>0.0117</td> </tr> </tbody> </table> <p>C: Step Time</p> <table border="1"> <thead> <tr> <th></th> <th>[us]</th> </tr> </thead> <tbody> <tr> <td>FS-B8KU7DCLU</td> <td>0.4</td> </tr> <tr> <td>FS-B4KU7DCLU,FS-B2KU7DCLU</td> <td>0.2</td> </tr> </tbody> </table>			Sync Mode		1:External Sync	2:Internal Sync	Exposure Mode	0: <u>Line</u>	External Sync Line Exposure	Internal Sync	1: Fix	External Sync Fix Exposure	2: Pulse	External Sync Pulse Exposure		[us]	FS-B8KU7DCLU	0.0235	FS-B4KU7DCLU,FS-B2KU7DCLU	0.0117		[us]	FS-B8KU7DCLU	0.4	FS-B4KU7DCLU,FS-B2KU7DCLU	0.2
					Sync Mode																							
		1:External Sync	2:Internal Sync																									
Exposure Mode	0: <u>Line</u>	External Sync Line Exposure	Internal Sync																									
	1: Fix	External Sync Fix Exposure																										
	2: Pulse	External Sync Pulse Exposure																										
	[us]																											
FS-B8KU7DCLU	0.0235																											
FS-B4KU7DCLU,FS-B2KU7DCLU	0.0117																											
	[us]																											
FS-B8KU7DCLU	0.4																											
FS-B4KU7DCLU,FS-B2KU7DCLU	0.2																											
11h.0-1	<p>【Sync Mode】 Initial Data:2 To set the camera sync.</p> <p>0:No function 1:External Sync 2:Internal Sync 3:No function</p> <p>After this parameter has been set, the FFC should be reset due to the CMOS output character being changed.</p>																											

Command No. Bit No.	Command Description
12h.0	<p>【Video Out】 Initial Data:0 To set the camera output bit.</p> <p><u>0:8bit</u> 1:10bit</p> <p>*Configurable output bit are depends on output mode. Some modes are 8bit only.</p>
20-21h	<p>【Exposure Time】 Initial Data:0 To set the camera exposure time.</p> <p>0~65535</p> <p>*When sync control is Internal, Exposure Time becomes a Line period, so you can change the Line period of camera by the setting value of this parameter.</p>
31h	<p>【Digital Gain】 Initial Data:0 To set the Digital Gain.(This process works after received the data from sensor).</p> <p>0~255</p> <p>Digital gain formula is the following. Gained Value = (1 + Digital Gain /64)*(Brightness Level - FFC Offset Target) + FFC Offset Target</p> <p>*This formula is based on FFC. This value is clamped by FFC Offset Target.</p>
34h.0	<p>【Analog Gain】 Initial Data:0 To set the Analog Gain.(This process works on the CMOS's sensor registry).</p> <p><u>0:OFF</u> 1:ON (x 4)</p> <p>After this parameter has been set, the FFC should be reset for CMOS output due to the character being changed.</p>
78h	<p>【Test Pattern】 Initial Data:0 To set the Test pattern output.</p> <p><u>0:OFF</u> 1:Sawtooth wave 2:Triangle wave 3:Gray Scale 128 Steps 4:Moving Sawtooth wave</p>

Command No. Bit No.	Command Description																								
81h	<p>【FFC Mode】 Initial Data:1 To set the FFC mode.</p> <table border="0"> <tr> <td>0:OFF</td> <td>=></td> <td>Non-correction video output</td> </tr> <tr> <td><u>1:ON (Gain + Offset)</u></td> <td>=></td> <td>Corrected video output (Gain + Offset)</td> </tr> <tr> <td>2:FFC value</td> <td>=></td> <td>FFC value output on the video signal</td> </tr> <tr> <td>3:Manual (by pixel)</td> <td>=></td> <td>Set the correction value into each pixel</td> </tr> <tr> <td>4:Manual (all pixels)</td> <td>=></td> <td>Set the correction value into the all pixels</td> </tr> <tr> <td>5:Auto (Gain)</td> <td>=></td> <td>Calculate the correct Gain value automatically</td> </tr> <tr> <td>6:Auto (Offset)</td> <td>=></td> <td>Calculate the correct Offset value automatically.</td> </tr> <tr> <td>7:ON (only Offset)</td> <td>=></td> <td>Corrected video output (only Offset)</td> </tr> </table> <p>*The camera will start the operation when changing the mode under Auto setting.</p>	0:OFF	=>	Non-correction video output	<u>1:ON (Gain + Offset)</u>	=>	Corrected video output (Gain + Offset)	2:FFC value	=>	FFC value output on the video signal	3:Manual (by pixel)	=>	Set the correction value into each pixel	4:Manual (all pixels)	=>	Set the correction value into the all pixels	5:Auto (Gain)	=>	Calculate the correct Gain value automatically	6:Auto (Offset)	=>	Calculate the correct Offset value automatically.	7:ON (only Offset)	=>	Corrected video output (only Offset)
0:OFF	=>	Non-correction video output																							
<u>1:ON (Gain + Offset)</u>	=>	Corrected video output (Gain + Offset)																							
2:FFC value	=>	FFC value output on the video signal																							
3:Manual (by pixel)	=>	Set the correction value into each pixel																							
4:Manual (all pixels)	=>	Set the correction value into the all pixels																							
5:Auto (Gain)	=>	Calculate the correct Gain value automatically																							
6:Auto (Offset)	=>	Calculate the correct Offset value automatically.																							
7:ON (only Offset)	=>	Corrected video output (only Offset)																							
82h	<p>【Select FFC (Gain,Offset)】 Initial Data:1 To select Gain or Offset correction value on the Manual Mode of FFC Mode(81h).</p> <table border="0"> <tr> <td>0:Non</td> </tr> <tr> <td><u>1:Gain</u></td> </tr> <tr> <td>2:Offset</td> </tr> </table>	0:Non	<u>1:Gain</u>	2:Offset																					
0:Non																									
<u>1:Gain</u>																									
2:Offset																									
83h	<p>【FFC Corrected Value Output】 Initial Data:0 To select FFC corrected value on the FFC value of FFC Mode(81h).</p> <table border="0"> <tr> <td><u>0:Upper bit</u></td> </tr> <tr> <td>1:Lower bit</td> </tr> </table>	<u>0:Upper bit</u>	1:Lower bit																						
<u>0:Upper bit</u>																									
1:Lower bit																									
84-85h	<p>【FFC Data】 Initial Data:0 To set the corrected vale on the Manual Mode of FFC Mode(81h).</p> <p>0~65535</p>																								
86-87h	<p>【FFC Address】 Initial Data:0 To set the pixel address data on the Manual Mode of FFC Mode(81h).</p> <p>0~Maximum value (It depends on camera model)</p> <p>*Left side of image is as "0"</p>																								
88h	<p>【Target FFC Gain】 Initial Data:200 To set the target level(8bit) on Auto (Gain) mode of FFC Mode(81h).</p> <p>0~255</p>																								
8Ah	<p>【Target FFC Offset】 Initial Data:3 To set the target level(8bit) on Auto (Offset) mode of FFC Mode(81h).</p> <p>0~255</p>																								
8Ch	<p>【FFC Corrected Value Store Mode】 Initial Data:0 To set the saving mode of FCC corrected value.</p> <table border="0"> <tr> <td><u>0: User Default Access Area</u></td> <td>=></td> <td>Use the one corrected FFC value (Automatically changed for output mode)</td> </tr> <tr> <td>1: User BANK Area</td> <td>=></td> <td>Select the several corrected FFC value</td> </tr> </table> <p>*Under the Standard setting, corrected FFC value will be loaded automatically, if signal wave is changed for each output mode. As for the detail, please refer to the FFC Corrected Value Store Mode.</p>	<u>0: User Default Access Area</u>	=>	Use the one corrected FFC value (Automatically changed for output mode)	1: User BANK Area	=>	Select the several corrected FFC value																		
<u>0: User Default Access Area</u>	=>	Use the one corrected FFC value (Automatically changed for output mode)																							
1: User BANK Area	=>	Select the several corrected FFC value																							

Command No. Bit No.	Command Description									
8Dh	<p>【FFC Corrected Value Store Mode(Bank)】 Initial Data:0 To set the Bank number on Bank Mode of FFC Corrected Value Store Mode(8Ch). 0~7 *FFC value would not be loaded automatically even when changing this setting.</p>									
96h	<p>【Un-detect Chattering Period】 Initial Data:0 To set the time period of un-detect chattering. This function can be used the input trigger signal from CC1. The trigger is recognized through consecutive this number of high signal by CLK. 0~255</p>									
A7h	<p>【User ID】 Initial Data:0 To set the User ID. When several cameras are in use, each camera can be assigned a specific name. 0~255</p>									
ACh	<p>【BUSY】 Initial Data: Read Only To understand the communication status. 0: Enable the communication 1~255: Disable the communication</p>									
B0-B1h	<p>【AOI Start Pixel】 Initial Data:0 To set the start Pixel position. Maximum value depends on sensor size.</p>									
B7h	<p>【STATUS】 Initial Data : Read Only To read the FFC status.</p> <table border="1" style="margin-left: 20px;"> <tr> <td style="width: 50px;">D[7:0]</td> <td>D7</td> <td>D6</td> <td>D5</td> <td>D4</td> <td>D3</td> <td>D2</td> <td>D1</td> <td>D0</td> </tr> </table> <p> D7-5:No-function 0: Fix D4:Status of Shield light level 0: Normal 1: Shield light level is always 0 D3:FFC Gain over 0: Normal 1: Light receiving level is higher than Target level(Gain) D2:FFC Gain short 0: Normal 1: Light receiving level is lower than Target level(Gain) D1:FFC Offset over 0: Normal 1: Shield light level is bigger than maximum offset D0:FFC Offset short 0: Normal 1: Shield light level is lower than Black level </p>	D[7:0]	D7	D6	D5	D4	D3	D2	D1	D0
D[7:0]	D7	D6	D5	D4	D3	D2	D1	D0		
C0-C1h	<p>【AOI width of LVAL】 Initial Data: Maximum of pixel number for each model To set the valuable length on AOI image. Maximum value depends on sensor size.</p>									

Command No. Bit No.	Command Description
CBh.0-1	<p>【Communication Mode】 Initial Data: 0 To set the Specific Communication Mode. Please set this parameter "ON", when external sync does not input camera. 0:OFF Normal Mode (Communication just only work with external sync) 1:ON Specific Communication Mode (Internal Sync mode without video image output) 2-3:Invalid</p>
E0h.4	<p>【Clear FFC(Gain) RAM】 Initial Data: Write Only To clear the FFC Gain data on the RAM. Set "1"</p>
E1h.1	<p>【Clear FFC(Offset) RAM】 Initial Data: Write Only To clear the FFC Offset in data on the RAM. Set "1"</p>
E1h.3	<p>【Load FFC(Factory setting)】 Initial Data: Write Only To load the FFC Gain(Factory setting). Set "1"</p>
E1h.4	<p>【Set FFC】 Initial Data: Write Only To set the FFC value when FFC Manual mode was selected(81h). Set "1"</p>
E1h.6	<p>【Save FFC】 Initial Data: Write Only To save the FFC Gain value into the RAM. Set "1"</p>
E1h.7	<p>【Load FFC】 Initial Data: Write Only To load the FFC Gain from RAM. Set "1"</p>
E2h.0	<p>【Save Camera Setting】 Initial Data: Write Only To save the camera setting data into the RAM. Set "1"</p>
E2h.1	<p>【Load Camera Setting】 Initial Data: Write Only To load the camera setting data from RAM. Set "1"</p>
E2h.3	<p>【Load Camera Setting (Factory Default)】 Initial Data: Write Only To load the factory default setting from RAM. Set "1"</p>
Eeh	<p>【Output Mode】 Initial Data: It depends on camera model To set the camera output mode. Therefore it could be selectable of Camera link Full/Medium/Base configuration, Camera Link output CLK. Selectable Output Mode is different for each model. As for the detail, please see FS-B2KU7CLU,FS-B4KU35CLU,FS-B4K7CLU,FS-B8KU35CLU,FS-B8KU7CLU,FS-B16KU35CLU,Minimum line period *8bit (Fix)/10bit output can be selected through Output Mode. *Maximum Frame rate on Internal Sync can be selected through Output Mode. *FFC would be changed automatically through Output Mode when FFC Corrected Value Store Mode is Standard.</p>

7.2.2 Save the Camera Setting Data into FLASH

To save the camera setting data into FLASH, please follow the procedure below:

- Set "1" on E2h.0 to save the camera setting.

7.2.3 Sequence of Camera Power On

- 1) Power on the camera
- 2) Load the camera setting into the registry and storage FLASH RAM
- 3) Corrected FFC values load from FLASH

8 Test Patterns

8.1 FS-B2KU7CLU

tsmd=1



tsmd=2



tsmd=3



tsmd=4



8.2 FS-B4KU7CLU / FS-B4KU35CLU

tsmd=1



tsmd=2



tsmd=3



tsmd=4, Moving Sawtooth wave



8.3 FS-B8KU7CLU / FS-B8KU35CLU

tsmd=1



tsmd=2



tsmd=3 (Fix 8bit, 128 steps)



tsmd=4, Moving Sawtooth wave

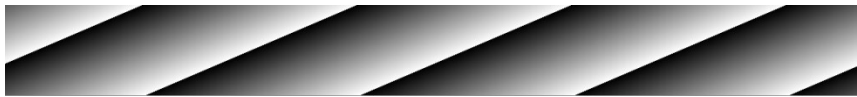

8.4 FS-B16KU35CLU

tsmd=1



tsmd=2



tsmd=3 (Fix 8bit, 128 steps)



tsmd=4, Moving Sawtooth wave



9. Field Update Function

Camera FPGA data can be overwritten via PC (Field Update)

9.1 Procedure

- 1) Launch the update software “StCLRemoteUpdate”.
- 2) Select the update file (rbf) and COM port that communicates with the camera and click “Update”.

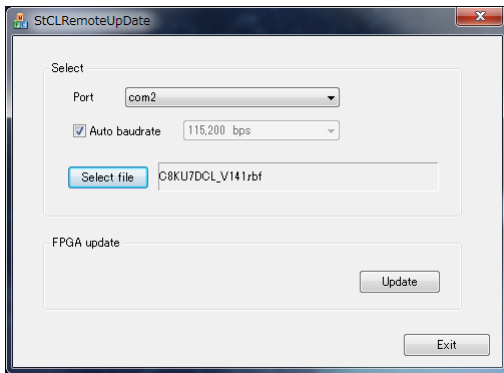

- 3) When finished uploading, power the camera off / on.

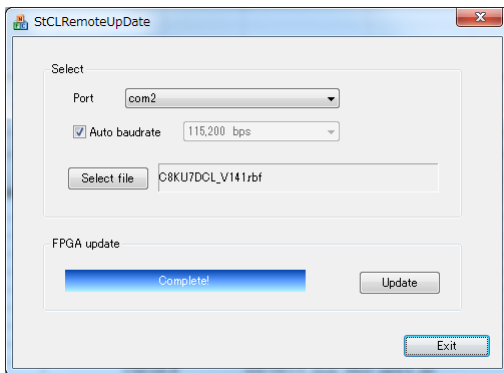

10 Quantum Efficiency

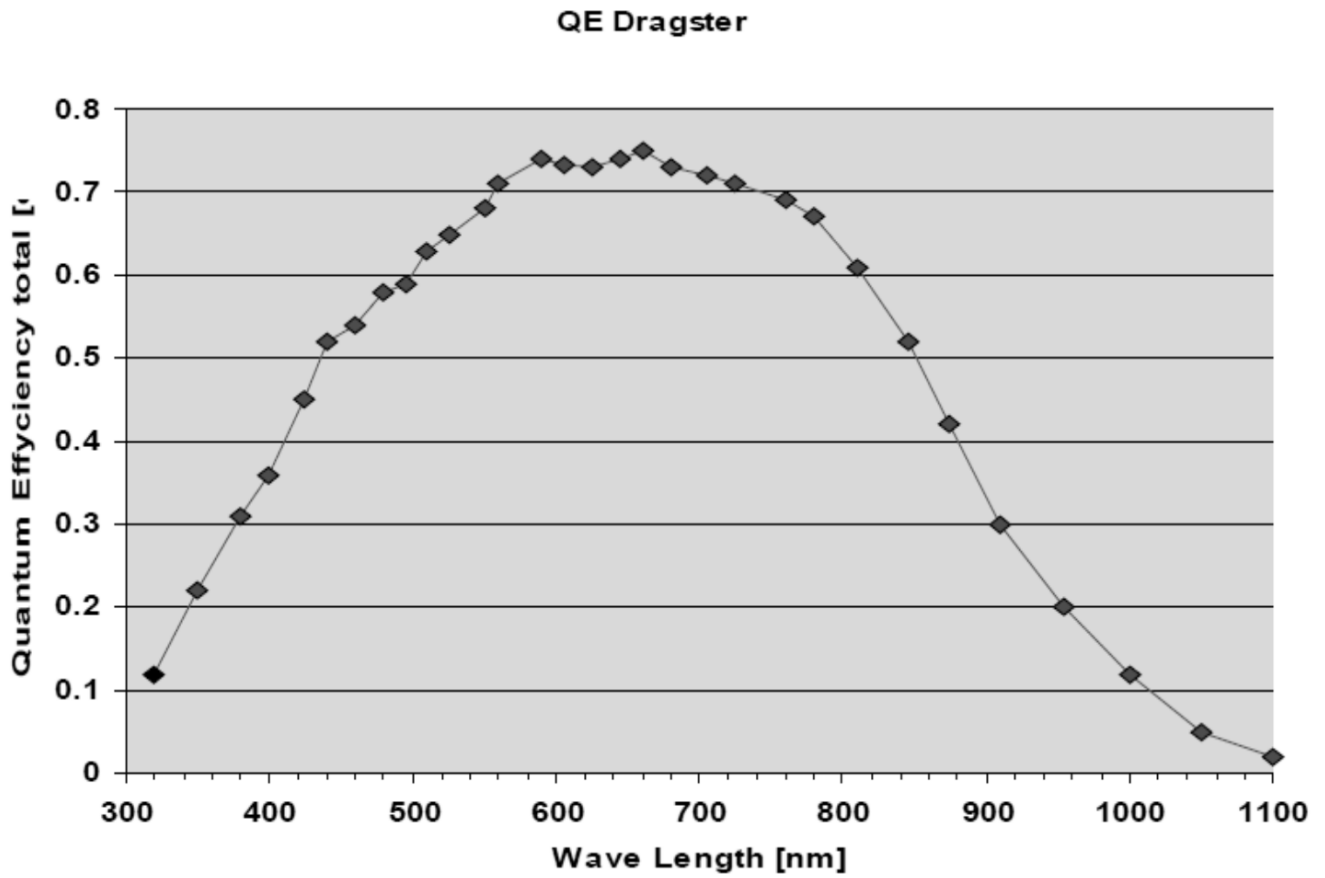

11 Dimensions

11.1 FS-B2KU7DCLU-C

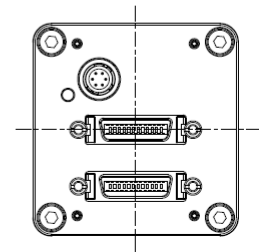
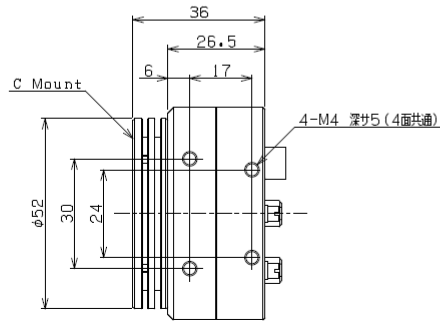
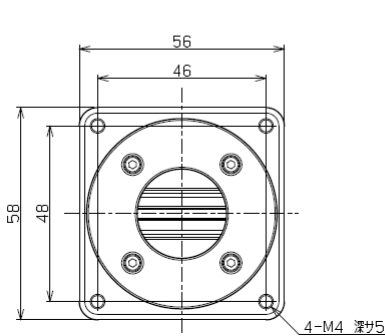
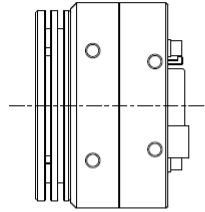
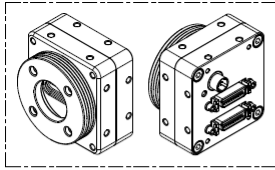

Unit: mm

11.2 FS-B8KU35CLU-F, FS-B4KU7CLU-F, FS-B4KU35CLU-F, FS-B2KU7CLU-F

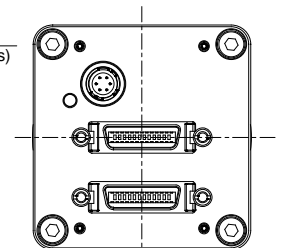
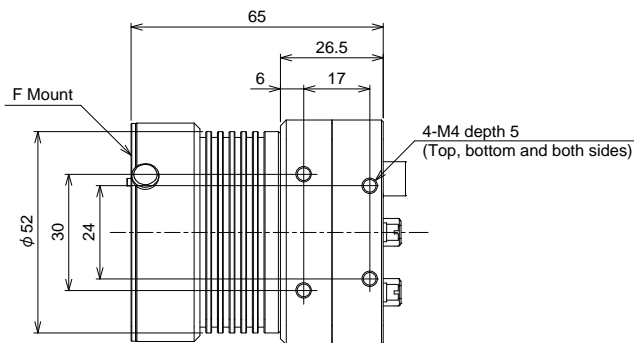
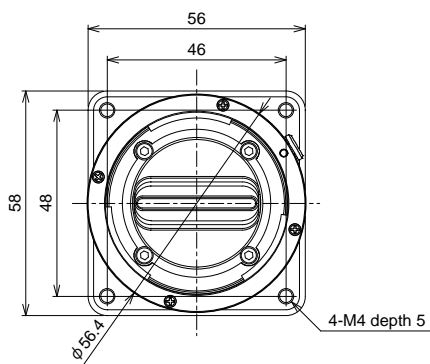
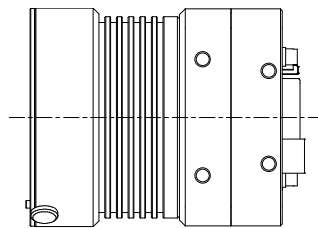
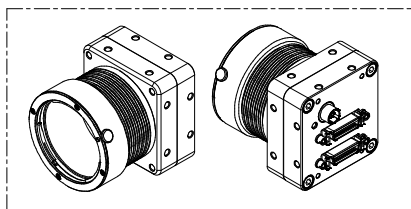

Unit: mm

11.3 FS-B16KU35CLU-M72, FS-B8KU7CLU-M72

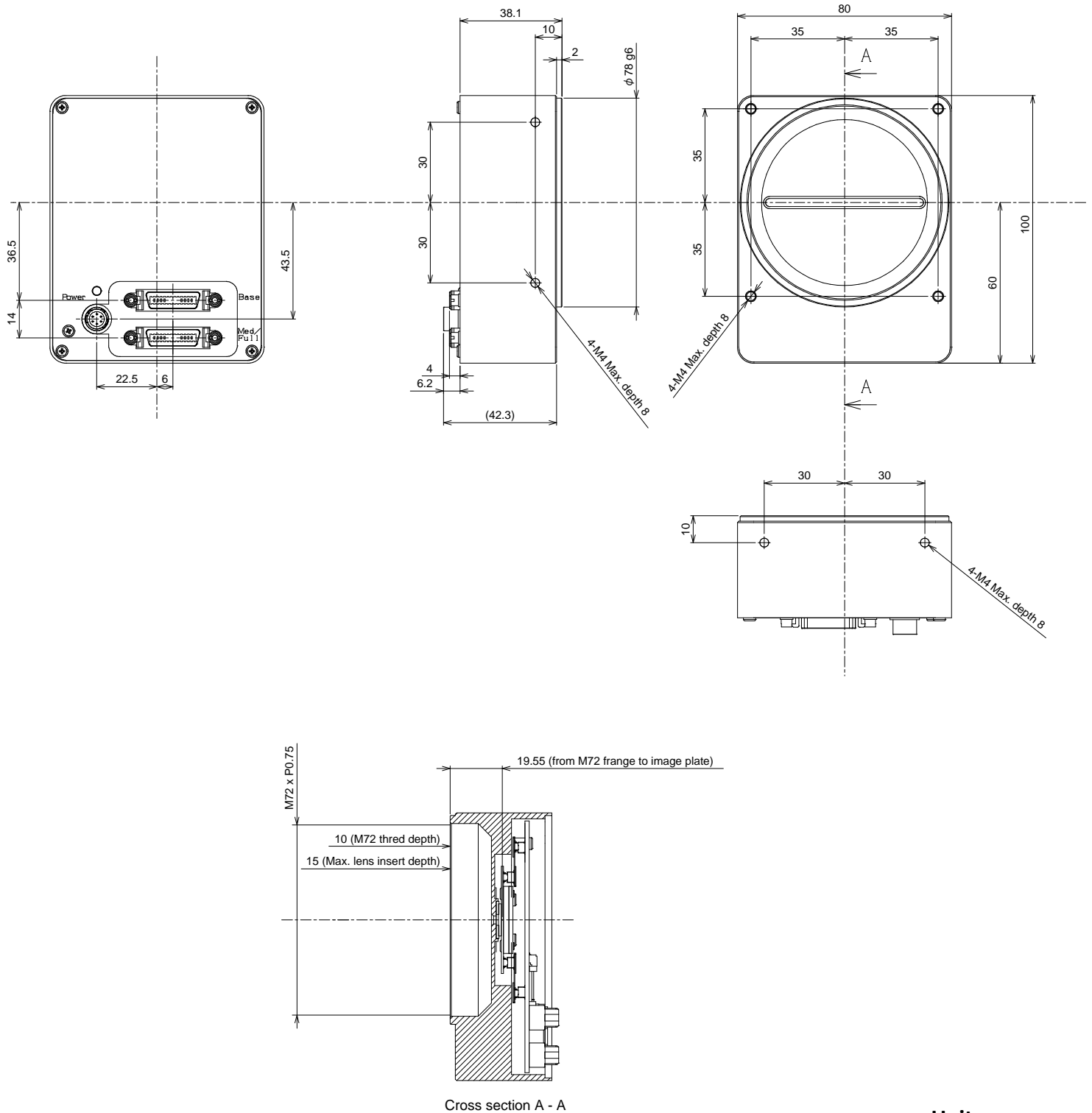

Unit: mm

Rev	Date	Changes	Note
1.11	October 30, 2013	Initial Release	RM
1.12	April 28, 2014	Revised FFC Explanation Added Registers Revised ASCII Info for Field Update Added Field Update Procedure	

Sensor Technologies America, Inc.

1345 Valwood Pkwy, Suite 320

Carrollton, TX 75006

TEL:(972)-481-9223

FAX: (972)-481-9209

www.SentechAmerica.com