

SENTECH

**GigE Vision Camera Series
(PoE) & (PoEHS)**

Safety Precautions

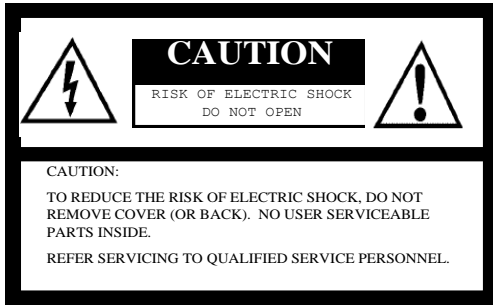

The lightning flash with arrowhead symbol, within an equilateral triangle, is intended to alert the user to the presence of uninsulated “dangerous voltage” within the product’s enclosure that may be of sufficient magnitude to constitute a risk of electric shock to persons.



The exclamation point within an equilateral triangle is intended to alert the user to the presence of important operating and maintenance (servicing) instructions in the literature accompanying the appliance.

For U.S.A.

Warning:

This equipment generates and uses radio frequency energy and if not installed and used properly, I.e., in strict accordance with the instruction manual, may cause harmful interference to radio communications. It has been tested and found to comply with the limits for a Class A computing device pursuant to Subpart J of Part 15 of FCC Rules, which are designed to provide reasonable protection against such interference when operated in a commercial environment.

For Canada

Warning:

This digital apparatus does not exceed the Class A limits for radio noise emissions from digital apparatus set out in the Radio Interference Regulations of the Canadian Department of Communications.

WARNING:

TO PREVENT FIRE OR SHOCK HAZARD, DO NOT EXPOSE THIS APPLIANCE TO RAIN OR MOISTURE.

Product Precautions

- Handle the camera with care. Do not abuse the camera. Avoid striking or shaking it. Improper handling or storage could damage the camera.
- Do not pull or damage the camera cable.
- During camera use, do not wrap the unit in any material. This will cause the internal temperature of the unit to increase.
- Do not expose the camera to moisture, or do not try to operate it in wet areas.
- Do not operate the camera beyond its temperature, humidity and power source ratings.
- While the camera is not being used, keep the lens or lens cap on the camera to prevent dust or contamination from getting in the CCD or filter area and scratching or damaging this area.
- Do not keep the camera under the following conditions:
 - In wet, moist, and high humidity areas
 - Under hot direct sunlight
 - In high temperature areas
 - Near an object that releases a strong magnetic or electric field
 - Areas with strong vibrations
- Use a soft cloth to clean the camera. Use pressured air spray to clean the surface of the glass. DO not scratch the surface of the glass.

Copyright & Disclaimer

Sensor Technologies America, Inc. (DBA Sentech America) believes the contents and specifications of its website, catalog, documentation and ads are correct; however, Sentech America provides no representation or warranty regarding such information or product(s) contained therein. It is requested that Sentech America be given appropriate acknowledgement in any subsequent use of such work by a third party.

While every effort has been made to ensure that the details contained in Sentech America's website and all documentation are correct and up-to-date, Sentech America assumes no liability, legal or otherwise for any errors in listings, specifications, part numbers, process, software or model applications. Sentech America reserves the right to change specifications, product descriptions, product quality, pricing and application at any time without prior written or oral notice. Any party using such information assumes all risk for any and all damaged caused to themselves, a third party and/or property by virtue of incorrect information and/or failure of these products. By installing and/or using a Sentech America software development kit or other similar product and/or information obtained from Sentech America's website, catalog, documentation or ads, you hereby accept and understand these stated terms and conditions.

Table of Contents

I. Product Precautions	6
II. General Specifications	7-24
A. Electronic Specifications	7-16
1. STC-SB33POE / SC33POE.....	7
2. STC-SB83POE / SC83POE.....	8
3. STC-SB152POE / SC152POE.....	9
4. STC-SB202POE / SC202POE.....	10
5. STC-SB500POE / SC500POE.....	11
6. STC-SB33POEHS / SC33POEHS	12
7. STC-SB32POEHS / SC32POEHS	13
8. STC-SB133POEHS / SC133POEHS	14
9. STC-SB152POEHS / SC152POEHS	15
10. STC-SB202POEHS / SC202POEHS	16
B. Spectral Sensitivity	17-23
1. STC-SB33POE / STC-SB33POEHS	17
2. STC-SC33POE / STC-SC33POEHS (with IR Cut Filter)	17
3. STC-SB32POEHS	18
4. STC-SC32POEHS (with IR Cut Filter)	18
5. STC-SB83POE.....	19
6. STC-SC83POE (with IR Cut Filter)	19
7. STC-SB133POEHS	20
8. STC-SC133POEHS (with IR Cut Filter)	20
9. STC-SB152POE / STC-SB152POEHS	21
10. STC-SC152POE / STC-SC2152POEHS (with IR Cut Filter)	21
11. STC-SB202POE / STC-SB202POEHS	22
12. STC-SC202POE / STC-SC202POEHS (with IR Cut Filter)	22
13. STC-SB500POE.....	23
14. STC-SC500POE (with IR Cut Filter)	23
C. Mechanical Specifications	24
D. Environmental Specifications	24
Product Specifications	4
	Ver 1.03

III. Connector Specifications	25-30
A. RJ45 Connector	25-26
1. Pin Assignment	25
2. LED Information	25-26
B. Power – I/O Connector	27-30
1. Pin Assignment	27
2. I/O Signal Patterns for Pin No. 2 (I/O-1) and Pin No. 3 (I/O-2)	27-29
3. Equivalent Circuit for the Input Pin of the I/O Connector	30
IV. Dimensions	31

I. Product Precautions

- Handle the camera with care. Do not abuse the camera. Avoid striking or shaking it. Improper handling or storage could damage the camera.
- Do not pull or damage the camera cable.
- During camera use, do not wrap the unit in any material. This will cause the internal temperature of the unit to increase.
- Do not expose the camera to moisture, or do not try to operate it in wet areas.
- Do not operate the camera beyond its temperature, humidity and power source ratings.
- While the camera is not being used, keep the lens or lens cap on the camera to prevent dust or contamination from getting in the CCD or filter area and scratching or damaging this area.
- Do not keep the camera under the following conditions:
 - In wet, moist, and high humidity areas
 - Under hot direct sunlight
 - In high temperature areas
 - Near an object that releases a strong magnetic or electric field
 - Areas with strong vibrations
- Apply the power that satisfies the requirements specified in this document to the camera.
- Use a soft cloth to clean the camera. Use pressured air spray to clean the surface of the glass. DO not scratch the surface of the glass.
- The camera is a general-purpose electronic device; using the camera for the equipment that may threaten human life or cause dangers to human bodies directly in case of failure or malfunction of the camera is not guaranteed. Use the camera for special purposes at your own risk.

II. General Specifications

A. Electronic Specifications

1. STC-SB33POE/SC33POE

Model Number		STC-SB33POE	STC-SC33POE
Imager		1/3" Interline VGA monochrome progressive CCD: ICX424AL	1/3" interline VGA color progressive CCD: ICX424AQ
Total Picture Elements		692 (H) x 504 (V)	
Active Picture Elements		VGA: 648 (H) x 494 (V)	
Cell Size		7.4 (H) x 7.4 (V) μm	
Scanning System		Progressive	
Vertical Frequency (Frame Rate)		89.91007 Hz at full resolution 0.72026 to 363.09837 Hz adjustable via the communication (Frame rate depends on the AOI setting) Maximum frame rate (363.09837 Hz) is when vertical resolution AOI setting is 78.	
Horizontal Frequency		47.2028 kHz	
Pixel Frequency		36.8181 MHz	
Noise Level	@ 8bit output	≤ 3 Digit (Gain 0 dB)	
	@ 10bit output	≤ 12 Digit (Gain 0 dB)	
	@ 12bit output	≤ 48 Digit (Gain 0 dB)	
Minimum Scene Illumination		0.58 Lux at F1.2, 89.91007Hz	25.75 Lux at F1.2, 89.91007Hz
Sync. System		Internal	
Video Output Format		Digital 8, 10 or 12 bit Raw Data	Digital 8, 10 or 12 bit Raw data or RGB 8 bit
Interface		PoE : IEEE802.3af CLASS2 (1000BASE-T)	
Protocol		GigE Vision® 1.2 and GenICam™ 2.0 compliant	
Exposure Time		Preset continuous mode: 0,10 useconds to 16,777,215 useconds Preset trigger mode: 0,10 useconds to 16,777,215 useconds Pulse width mode: 0,10 useconds to Unlimited '0':Electric shutter Off(Full exposure)	
ALC		AE and AGC (ON/OFF)	
Gain		0 to 20.4 dB	
Gamma		Gamma 1.0 (Factory default) or uploadable gamma table	
AOI Function		Variable AOI setting via the communication	
Smear Reduction		Selectable ON/OFF via the communication	
Color Interpolation		N/A	Available on RGB Output
White Balance		N/A	Auto, Manual, Push to Set White Balance are available on both raw data and RGB outputs
Operational Mode		Edge preset trigger, Pulse width trigger (unlimited long exposure) *Note1	
Communication		UART communication through Ethernet port	
I/O		One opt-isolated input and two open collector outputs	
Power	Input Voltage	+10.8 to +26.4 Vdc via power-I/O connector or Power over Ethernet (Power-I/O connector power supply is prioritized.)	
	Consumption (Max/Default)	12V: 2.9W/2.7W, PoE: 3.4W/3.1W	

2. STC-SB83POE/SC83POE

Model Number		STC-SB83POE	STC-SC83POE
Imager		1/3" interline XGA monochrome progressive CCD: ICX204AL	1/3" interline XGA color progressive CCD: ICX204AK
Total Picture Elements		1077 (H) x 788 (V)	
Active Picture Elements		XGA: 1024 (H) x 768 (V)	
Cell Size		4.65 (H) x 4.65 (V) μm	
Scanning System		Progressive	
Vertical Frequency (Frame Rate)		36.42046 Hz at full resolution 0.44236 to 145.68185 Hz changeable via the communication (Frame rate depends on the AOI setting) Maximum frame rate (145.68185 Hz) is when vertical resolution AOI setting is 94.	
Horizontal Frequency		28.9907 kHz	
Pixel Frequency		36.818175 MHz	
Noise Level	@ 8bit output	≤ 3 Digit (Gain 0 dB)	
	@ 10bit output	≤ 12 Digit (Gain 0 dB)	
	@ 12bit output	≤ 48 Digit (Gain 0 dB)	
Minimum Scene Illumination		1.536 Lux at F1.2, 36.42046 Hz	19.14 Lux at F1.2, 36.42046 Hz
Sync. System		Internal	
Video Output Format		Digital 8, 10 or 12 bit Raw Data	Digital 8, 10 or 12 bit Raw data or RGB 8 bit
Interface		PoE : IEEE802.3af CLASS2 (1000BASE-T)	
Protocol		GigE Vision [®] 1.2 and GenICam [™] 2.0 compliant	
Exposure Time		Preset continuous mode: 0,10 useconds to 16,777,215 useconds Preset trigger mode: 0,10 useconds to 16,777,215 useconds Pulse width mode: 0,10 useconds to Unlimited '0':Electric shutter Off(Full exposure)	
ALC		AE and AGC (ON/OFF)	
Gain		0 to 20.4 dB	
Gamma		Gamma 1.0 (Factory default) or uploadable gamma table	
AOI Function		Variable AOI setting via the communication	
Smear Reduction		Selectable ON/OFF via the communication	
Color Interpolation		N/A	Available on RGB Output
White Balance		N/A	Auto, Manual, Push to Set White Balance are available on both raw data and RGB outputs
Operational Mode		Edge preset trigger, Pulse width trigger (unlimited long exposure) *Note1	
Communication		UART communication through Ethernet port	
I/O		One opt-isolated input and two open collector outputs	
Power	Input Voltage	+10.8 to +26.4 Vdc via power-I/O connector or Power over Ethernet (Power-I/O connector power supply is prioritized.)	
	Consumption (Max/Default)	12V: 2.4W/2.3W, PoE: 2.6W/2.5W	

3. STC-SB152POE/SC152POE

Model Number		STC-SB152POE	STC-SC152POE
Imager		1/2" interline SXGA monochrome progressive CCD: ICX205AL	1/2" interline SXGA color progressive CCD: ICX205AK
Total Picture Elements		1434 (H) x 1050 (V)	
Active Picture Elements		SXGA: 1360 (H) x 1040 (V)	
Cell Size		4.65 (H) x 4.65 (V) μm	
Scanning System		Progressive	
Vertical Frequency (Frame Rate)		19.25919 Hz at full resolution 0.31386 to 77.03675 Hz changeable via the communication (Frame rate depends on the AOI setting) Maximum frame rate (77.03675 Hz) is when vertical resolution AOI setting is 199.	
Horizontal Frequency		20.5688 kHz	
Pixel Frequency		36.8181MHz	
Noise Level	@ 8bit output	≤ 3 Digit (Gain 0 dB)	
	@ 10bit output	≤ 12 Digit (Gain 0 dB)	
	@ 12bit output	≤ 48 Digit (Gain 0 dB)	
Minimum Scene Illumination		0.41 Lux at F1.2, 19.25954 Hz	15.49 Lux at F1.2, 19.25954 Hz
Sync. System		Internal	
Video Output Format		Digital 8, 10 or 12 bit Raw Data	Digital 8, 10 or 12 bit Raw data or RGB 8 bit
Interface		PoE : IEEE802.3af CLASS2 (1000BASE-T)	
Protocol		GigE Vision® 1.2 and GenICam™ 2.0 compliant	
Exposure Time		Preset continuous mode: 0,10 useconds to 16,777,215 useconds Preset trigger mode: 0,10 useconds to 16,777,215 useconds Pulse width mode: 0,10 useconds to Unlimited '0':Electric shutter Off(Full exposure)	
ALC		AE and AGC (ON/OFF)	
Gain		0 to 20.4 dB	
Gamma		Gamma 1.0 (Factory default) or uploadable gamma table	
AOI Function		Variable AOI setting via the communication	
Smear Reduction		Selectable ON/OFF via the communication	
Color Interpolation		N/A	Available on RGB Output
White Balance		N/A	Auto, Manual, Push to Set White Balance are available on both raw data and RGB outputs
Operational Mode		Edge preset trigger, Pulse width trigger (unlimited long exposure) *Note1	
Communication		UART communication through Ethernet port	
I/O		One opt-isolated input and two open collector outputs	
Power	Input Voltage	+10.8 to +26.4 Vdc via power-I/O connector or Power over Ethernet (Power-I/O connector power supply is prioritized.)	
	Consumption (Max/Default)	12V: 2.9W/2.8W, PoE: 3.3W/3.1W	

4. STC-SB202POE/SC202POE

Model Number		STC-SB202POE	STC-SC202POE
Imager		1/1.8" interline UXGA monochrome progressive CCD: ICX274AL	1/1.8" interline UXGA color progressive CCD: ICX274AQ
Total Picture Elements		1688(H)x1248(V)	
Active Picture Elements		UXGA: 1624 (H) x 1236 (V)	
Cell Size		4.4 (H) x 4.4 (V) μm	
Scanning System		Progressive	
Vertical Frequency (Frame Rate)		15.31640 Hz at full resolution 0.29261 to 61.26600 Hz changeable via the communication (Frame rate depends on the AOI setting) Maximum frame rate (61.26600 Hz) is when vertical resolution AOI setting is 232.	
Horizontal Frequency		19.1761 kHz	
Pixel Frequency		36.8181MHz	
Noise Level	@ 8bit output	≤ 3 Digit (Gain 0 dB)	
	@ 10bit output	≤ 12 Digit (Gain 0 dB)	
	@ 12bit output	≤ 48 Digit (Gain 0 dB)	
Minimum Scene Illumination		0.156 Lux at F1.2, 15.31640 Hz	7.272Lux at F1.2, 15.31640 Hz
Sync. System		Internal	
Video Output Format		Digital 8, 10 or 12 bit Raw Data	Digital 8, 10 or 12 bit Raw data or RGB 8 bit
Interface		PoE : IEEE802.3af CLASS2 (1000BASE-T)	
Protocol		GigE Vision® 1.2 and GenICam™ 2.0 compliant	
Exposure Time		Preset continuous mode: 0,10 useconds to 16,777,215 useconds Preset trigger mode: 0,10 useconds to 16,777,215 useconds Pulse width mode: 0,10 useconds to Unlimited '0':Electric shutter Off(Full exposure)	
ALC		AE and AGC (ON/OFF)	
Gain		0 to 20.4 dB	
Gamma		Gamma 1.0 (Factory default) or uploadable gamma table	
AOI Function		Variable AOI setting via the communication	
Smear Reduction		Selectable ON/OFF via the communication	
Color Interpolation		N/A	Available on RGB Output
White Balance		N/A	Auto, Manual, Push to Set White Balance are available on both raw data and RGB outputs
Operational Mode		Edge preset trigger, Pulse width trigger (unlimited long exposure) *Note1	
Communication		UART communication through Ethernet port	
I/O		One opt-isolated input and two open collector outputs	
Power	Input Voltage	+10.8 to +26.4 Vdc via power-I/O connector or Power over Ethernet (Power-I/O connector power supply is prioritized.)	
	Consumption (Max/Default)	12V: 3.0W/2.9W, PoE: 3.3W/3.3W	

5. STC-SB500POE/SC500POE

Model Number		STC-SB500POE	STC-SC500POE
Imager		2/3" interline QSXGA monochrome progressive CCD: ICX625AL	2/3" interline QSXGA color progressive CCD: ICX625AQ
Total Picture Elements		2536 (H) x 2068 (V)	
Active Picture Elements		QSXGA: 2448 (H) x 2058 (V)	
Cell Size		3.45 (H) x 3.45 (V) μm	
Scanning System		Progressive	
Vertical Frequency (Frame Rate)		15.18586 Hz at full resolution 0.48175 to 60.71422 Hz adjustable via the communication (Frame rate depends on the AOI setting.) Maximum frame rate (60.71422 Hz) is when vertical resolution AOI setting is 128. (For certain video output format, frame rate may drop due to the limitation of Gigabit Ethernet transfer rate.)	
Horizontal Frequency		31.5657KHz	
Pixel Frequency		81.8182 MHz	
Noise Level	@ 8bit output	≤ 4 Digit (Gain 0 dB)	
	@ 10bit output	≤ 15 Digit (Gain 0 dB)	
	@ 12bit output	≤ 60 Digit (Gain 0 dB)	
Minimum Scene Illumination		0.10 Lux at F1.2, 15.18586 Hz	6.48Lux at F1.2, 15.18586 Hz z
Sync. System		Internal	
Video Output Format		Digital 8, 10 or 12 bit Raw Data	Digital 8, 10 or 12 bit Raw data or RGB 8 bit
Interface		PoE : IEEE802.3af CLASS2 (1000BASE-T)	
Protocol		GigE Vision® 1.2 and GenICam™ 2.0 compliant	
Exposure Time		Preset continuous mode: 0,10 useconds to 16,777,215 useconds Preset trigger mode: 0,10 useconds to 16,777,215 useconds Pulse width mode: 0,10 useconds to Unlimited '0':Electric shutter Off(Full exposure)	
ALC		AE and AGC (ON/OFF)	
Gain		0 to 18.309 dB	
Gamma		Gamma 1.0 (Factory default) or uploadable gamma table	
AOI Function		Variable AOI setting via the communication	
Smear Reduction		Selectable ON/OFF via the communication	
Color Interpolation		N/A	Available on RGB Output
White Balance		N/A	Auto, Manual, Push to Set White Balance are available on both raw data and RGB outputs
Operational Mode		Edge preset trigger, Pulse width trigger (unlimited long exposure) *Note1	
Communication		UART communication through Ethernet port	
I/O		One opt-isolated input and two open collector outputs	
Power	Input Voltage	+10.8 to +26.4 Vdc via power-I/O connector or Power over Ethernet (Power-I/O connector power supply is prioritized.)	
	Consumption (Max/Default)	12V: 4.1W/3.5W, PoE: 4.5W/3.8W	

6. STC-SB33POEHS/SC33POEHS

Model Number		STC-SB33POEHS	STC-SC33POEHS
Imager		1/3" Interline VGA monochrome progressive CCD: ICX424AL	1/3" interline VGA color progressive CCD: ICX424AQ
Total Picture Elements		692 (H) x 504 (V)	
Active Picture Elements		VGA: 648 (H) x 494 (V)	
Cell Size		7.4 (H) x 7.4 (V) μm	
Scanning System		Progressive	
Vertical Frequency (Frame Rate)		122.27770 Hz at full resolution 0.97957 to 486.33176 Hz adjustable via the communication (Frame rate depends on the AOI setting) Maximum frame rate (486.33176 Hz) is when vertical resolution AOI setting is 80.	
Horizontal Frequency		64.19536KHz	
Pixel Frequency		50.0727MHz	
Noise Level	@ 8bit output	≤ 3 Digit (Gain 0 dB)	
	@ 10bit output	≤ 12 Digit (Gain 0 dB)	
	@ 12bit output	≤ 48 Digit (Gain 0 dB)	
Minimum Scene Illumination		1.464 Lux at F1.2, 122.27770Hz	46.728 Lux at F1.2, 122.27770Hz
Sync. System		Internal	
Video Output Format		Digital 8, 10 or 12 bit Raw Data	Digital 8, 10 or 12 bit Raw data or RGB 8 bit
Interface		PoE : IEEE802.3af CLASS2 (1000BASE-T)	
Protocol		GigE Vision® 1.2 and GenICam™ 2.0 compliant	
Exposure Time		Preset continuous mode: 0,10 useconds to 16,777,215 useconds Preset trigger mode: 0,10 useconds to 16,777,215 useconds Pulse width mode: 0,10 useconds to Unlimited '0':Electric shutter Off(Full exposure)	
ALC		AE and AGC (ON/OFF)	
Gain		0 to 18.309 dB	
Gamma		Gamma 1.0 (Factory default) or uploadable gamma table	
AOI Function		Variable AOI setting via the communication	
Smear Reduction		Selectable ON/OFF via the communication	
Color Interpolation		N/A	Available on RGB Output
White Balance		N/A	Auto, Manual, Push to Set White Balance are available on both raw data and RGB outputs
Operational Mode		Edge preset trigger, Pulse width trigger (unlimited long exposure) *Note1	
Communication		UART communication through Ethernet port	
I/O		One opt-isolated input and two open collector outputs	
Power	Input Voltage	+10.8 to +26.4 Vdc via power-I/O connector or Power over Ethernet (Power-I/O connector power supply is prioritized.)	
	Consumption (Max/Default)	12V: 3.2W/2.9W, PoE: 3.4W/3.1W	

7. STC-SB32POEHS/SC32POEHS

Model Number		STC-SB32POEHS	STC-SC32POEHS
Imager		1/2" interline VGA monochrome progressive CCD: ICX414AL	1/2" interline VGA color progressive CCD: ICX414AQ
Total Picture Elements		659(H)x494(V)	
Active Picture Elements		VGA: 648 (H) x 494 (V)	
Cell Size		9.9 (H) x 9.9 (V) μm	
Scanning System		Progressive	
Vertical Frequency (Frame Rate)		122.27770 Hz at full resolution 0.97957 to 486.33176 Hz adjustable via the communication (Frame rate depends on the AOI setting) Maximum frame rate (486.33176 Hz) is when vertical resolution AOI setting is 80.	
Horizontal Frequency		64.19536KHz	
Pixel Frequency		50.07272 MHz	
Noise Level	@ 8bit output	≤ 3 Digit (Gain 0 dB)	
	@ 10bit output	≤ 12 Digit (Gain 0 dB)	
	@ 12bit output	≤ 48 Digit (Gain 0 dB)	
Minimum Scene Illumination		1.2 Lux at F1.2, 122.27770Hz	43.64 Lux at F1.2, 122.27770Hz
Sync. System		Internal	
Video Output Format		Digital 8, 10 or 12 bit Raw Data	Digital 8, 10 or 12 bit Raw data or RGB 8 bit
Interface		PoE : IEEE802.3af CLASS2 (1000BASE-T)	
Protocol		GigE Vision® 1.2 and GenICam™ 2.0 compliant	
Exposure Time		Preset continuous mode: 0,10 useconds to 16,777,215 useconds Preset trigger mode: 0,10 useconds to 16,777,215 useconds Pulse width mode: 0,10 useconds to Unlimited '0':Electric shutter Off(Full exposure)	
ALC		AE and AGC (ON/OFF)	
Gain		0 to 18.309 dB	
Gamma		Gamma 1.0 (Factory default) or uploadable gamma table	
AOI Function		Variable AOI setting via the communication	
Smear Reduction		Selectable ON/OFF via the communication	
Color Interpolation		N/A	Available on RGB Output
White Balance		N/A	Auto, Manual, Push to Set White Balance are available on both raw data and RGB outputs
Operational Mode		Edge preset trigger, Pulse width trigger (unlimited long exposure) *Note1	
Communication		UART communication through Ethernet port	
I/O		One opt-isolated input and two open collector outputs	
Power	Input Voltage	+10.8 to +26.4 Vdc via power-I/O connector or Power over Ethernet (Power-I/O connector power supply is prioritized.)	
	Consumption (Max/Default)	12V: 3.4W/2.9W, PoE: 3.7W/3.2W	

8. STC-SB133POEHS/SC133POEHS

Model Number		STC-SB133POEHS	STC-SC133POEHS
Imager		1/3" Interline SXGA monochrome progressive CCD: ICX445AL	1/3" interline SXGA color progressive CCD: ICX445AQ
Total Picture Elements		1348 (H) x 976 (V)	
Active Picture Elements		SXGA: 1280 (H) x 966 (V)	
Cell Size		3.75 (H) x 3.75 (V) μm	
Scanning System		Progressive	
Vertical Frequency (Frame Rate)		39.82294 Hz at full resolution 0.60158 to 159.61423 Hz adjustable via the communication (Frame rate depends on the AOI setting) Maximum frame rate (159.61423 Hz) is when vertical resolution AOI setting is 168.	
Horizontal Frequency		39.4247 kHz	
Pixel Frequency		65.4545MHz	
Noise Level	@ 8bit output	≤ 4 Digit (Gain 0 dB)	
	@ 10bit output	≤ 15 Digit (Gain 0 dB)	
	@ 12bit output	≤ 60 Digit (Gain 0 dB)	
Minimum Scene Illumination		0.276 Lux at F1.2, 39.82294 Hz	19.488 Lux at F1.2, 39.82294 Hz
Sync. System		Internal	
Video Output Format		Digital 8, 10 or 12 bit Raw Data	Digital 8, 10 or 12 bit Raw data or RGB 8 bit
Interface		PoE : IEEE802.3af CLASS2 (1000BASE-T)	
Protocol		GigE Vision® 1.2 and GenICam™ 2.0 compliant	
Exposure Time		Preset continuous mode: 0,10 useconds to 16,777,215 useconds Preset trigger mode: 0,10 useconds to 16,777,215 useconds Pulse width mode: 0,10 useconds to Unlimited '0':Electric shutter Off(Full exposure)	
ALC		AE and AGC (ON/OFF)	
Gain		0 to 18.309 dB	
Gamma		Gamma 1.0 (Factory default) or uploadable gamma table	
AOI Function		Variable AOI setting via the communication	
Smear Reduction		Selectable ON/OFF via the communication	
Color Interpolation		N/A	Available on RGB Output
White Balance		N/A	Auto, Manual, Push to Set White Balance are available on both raw data and RGB outputs
Operational Mode		Edge preset trigger, Pulse width trigger (unlimited long exposure) *Note1	
Communication		UART communication through Ethernet port	
I/O		One opt-isolated input and two open collector outputs	
Power	Input Voltage	+10.8 to +26.4 Vdc via power-I/O connector or Power over Ethernet (Power-I/O connector power supply is prioritized.)	
	Consumption (Max/Default)	12V: 3.0W/2.8W, PoE: 3.3W/3.1W	

9. STC-SB152POEHS/SC152POEHS

Model Number		STC-SB152POEHS	STC-SC152POEHS
Imager		1/2" interline SXGA monochrome progressive CCD: ICX267AL	1/2" interline SXGA color progressive CCD: ICX267AK
Total Picture Elements		1434 (H) x 1050 (V)	
Active Picture Elements		SXGA: 1360 (H) x 1040 (V)	
Cell Size		4.65 (H) x 4.65 (V) μm	
Scanning System		Progressive	
Vertical Frequency (Frame Rate)		34.23358 Hz at full resolution 0.55789 to 136.93433 Hz changeable via the communication (Frame rate depends on the AOI setting) Maximum frame rate (136.93433 Hz) is when vertical resolution AOI setting is 122.	
Horizontal Frequency		36.56147 KHz	
Pixel Frequency		65.4545MHz	
Noise Level	@ 8bit output	≤ 4 Digit (Gain 0 dB)	
	@ 10bit output	≤ 15 Digit (Gain 0 dB)	
	@ 12bit output	≤ 60 Digit (Gain 0 dB)	
Minimum Scene Illumination		0.996 Lux at F1.2, 39.82294 Hz	27.684 Lux at F1.2, 39.82294 Hz
Sync. System		Internal	
Video Output Format		Digital 8, 10 or 12 bit Raw Data	Digital 8, 10 or 12 bit Raw data or RGB 8 bit
Interface		PoE : IEEE802.3af CLASS2 (1000BASE-T)	
Protocol		GigE Vision® 1.2 and GenICam™ 2.0 compliant	
Exposure Time		Preset continuous mode: 0,10 useconds to 16,777,215 useconds Preset trigger mode: 0,10 useconds to 16,777,215 useconds Pulse width mode: 0,10 useconds to Unlimited '0':Electric shutter Off(Full exposure)	
ALC		AE and AGC (ON/OFF)	
Gain		0 to 18.309 dB	
Gamma		Gamma 1.0 (Factory default) or uploadable gamma table	
AOI Function		Variable AOI setting via the communication	
Smear Reduction		Selectable ON/OFF via the communication	
Color Interpolation		N/A	Available on RGB Output
White Balance		N/A	Auto, Manual, Push to Set White Balance are available on both raw data and RGB outputs
Operational Mode		Edge preset trigger, Pulse width trigger (unlimited long exposure) *Note1	
Communication		UART communication through Ethernet port	
I/O		One opt-isolated input and two open collector outputs	
Power	Input Voltage	+10.8 to +26.4 Vdc via power-I/O connector or Power over Ethernet (Power-I/O connector power supply is prioritized.)	
	Consumption (Max/Default)	12V: 3.5W/3.2W, PoE: 3.7W/3.5W	

10. STC-SB202POEHS/SC202POEHS

Model Number		STC-SB202POEHS	STC-SC202POEHS
Imager		1/1.8" interline UXGA monochrome progressive CCD: ICX274AL	1/1.8" interline UXGA color progressive CCD: ICX274AQ
Total Picture Elements		1688 (H)x 1248 (V)	
Active Picture Elements		UXGA: 1624 (H) x 1236 (V)	
Cell Size		4.4 (H) x 4.4 (V) μ m	
Scanning System		Progressive	
Vertical Frequency (Frame Rate)		30.63280 Hz at full resolution 0.58522 to 122.53119 Hz changeable via the communication (Frame rate depends on the AOI setting) Maximum frame rate (122.53119 Hz) is when vertical resolution AOI setting is 112.	
Horizontal Frequency		38.352264 kHz	
Pixel Frequency		73.6364MHz	
Noise Level	@ 8bit output	≤ 4 Digit (Gain 0 dB)	
	@ 10bit output	≤ 15 Digit (Gain 0 dB)	
	@ 12bit output	≤ 60 Digit (Gain 0 dB)	
Minimum Scene Illumination		0.348Lux at F1.2, 30.63280 Hz	14.532Lux at F1.2, 30.63280 Hz
Sync. System		Internal	
Video Output Format		Digital 8, 10 or 12 bit Raw Data	Digital 8, 10 or 12 bit Raw data or RGB 8 bit
Interface		PoE : IEEE802.3af CLASS2 (1000BASE-T)	
Protocol		GigE Vision® 1.2 and GenICam™ 2.0 compliant	
Exposure Time		Preset continuous mode: 0,10 useconds to 16,777,215 useconds Preset trigger mode: 0,10 useconds to 16,777,215 useconds Pulse width mode: 0,10 useconds to Unlimited '0':Electric shutter Off(Full exposure)	
ALC		AE and AGC (ON/OFF)	
Gain		0 to 18.309 dB	
Gamma		Gamma 1.0 (Factory default) or uploadable gamma table	
AOI Function		Variable AOI setting via the communication	
Smear Reduction		Selectable ON/OFF via the communication	
Color Interpolation		N/A	Available on RGB Output
White Balance		N/A	Auto, Manual, Push to Set White Balance are available on both raw data and RGB outputs
Operational Mode		Edge preset trigger, Pulse width trigger (unlimited long exposure) *Note1	
Communication		UART communication through Ethernet port	
I/O		One opt-isolated input and two open collector outputs	
Power	Input Voltage	+10.8 to +26.4 Vdc via power-I/O connector or Power over Ethernet (Power-I/O connector power supply is prioritized.)	
	Consumption (Max/Default)	12V: 4.1W/3.9W, PoE: 4.4W/4.2W	

B. Spectral Sensitivity Characteristics

1. STC-SB33POE / STC-SB33POEHS

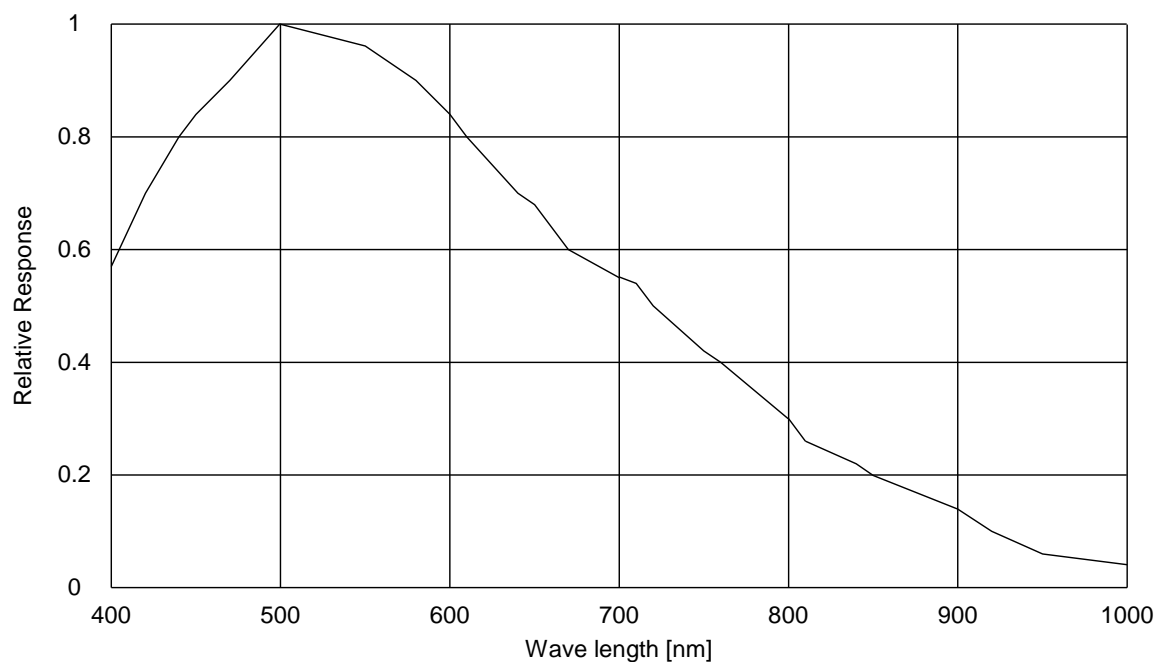

2. STC-SC33POE / STC-SC33POEHS (with IR Cut Filter)

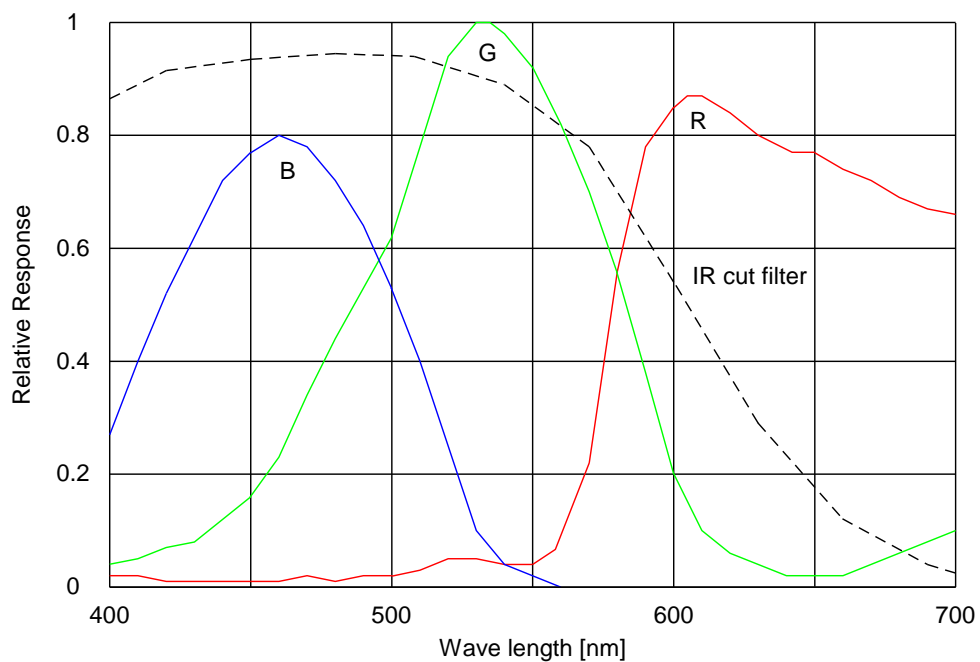

3. STC-SB32POE

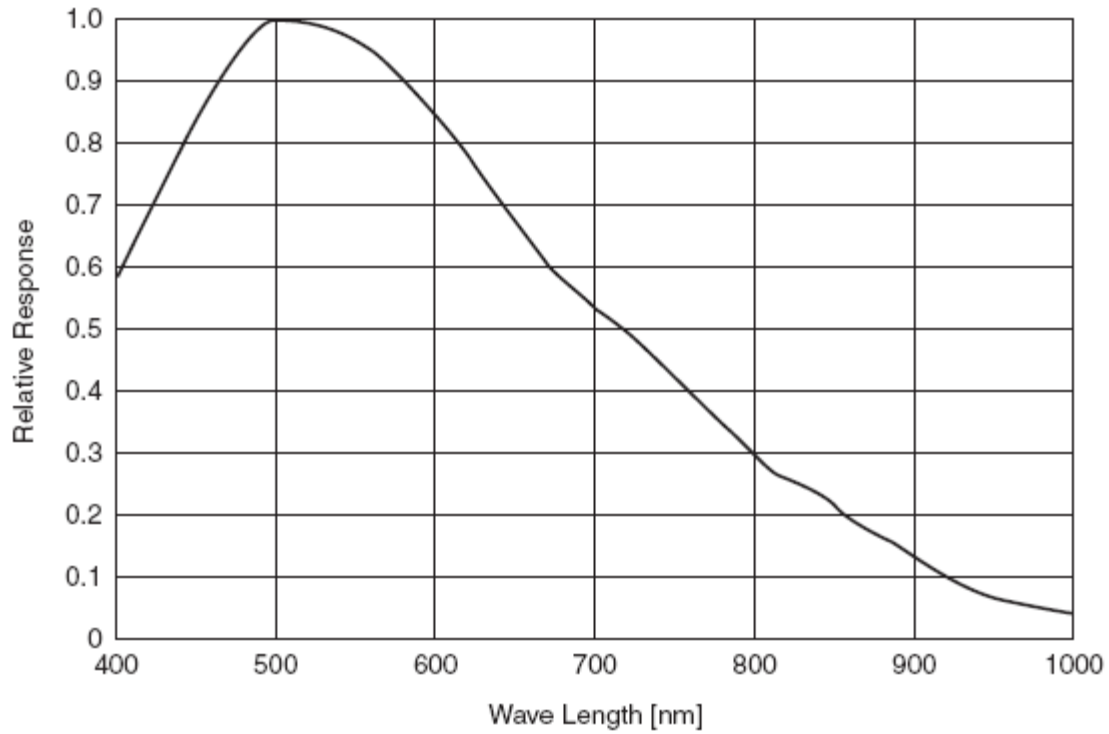

4. STC-SC32POE (with IR Cut Filter)

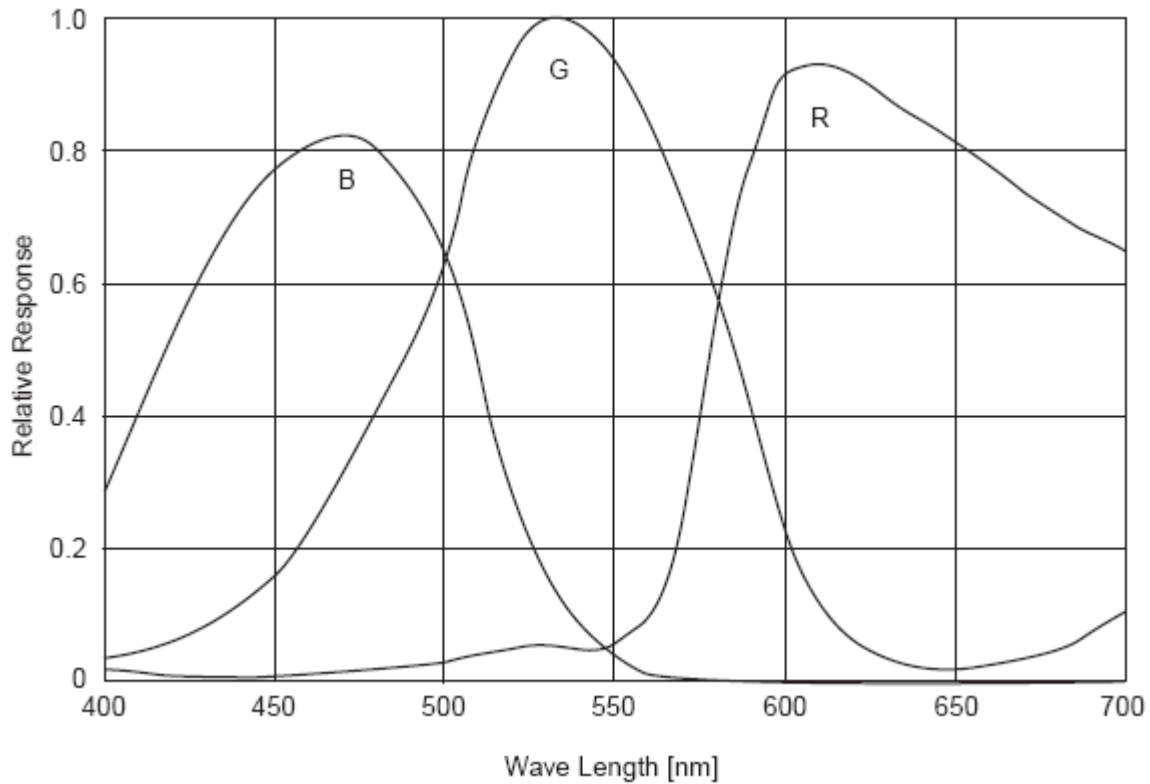

5. STC-SB83POE

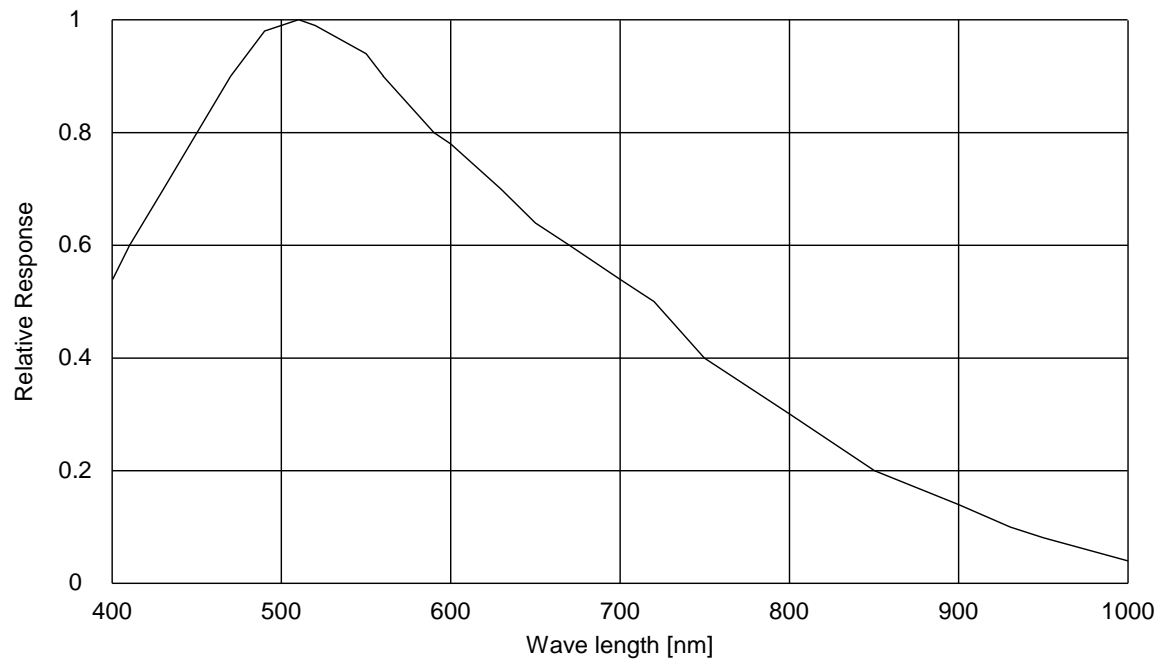

6. STC-SC83POE (with IR Cut Filter)

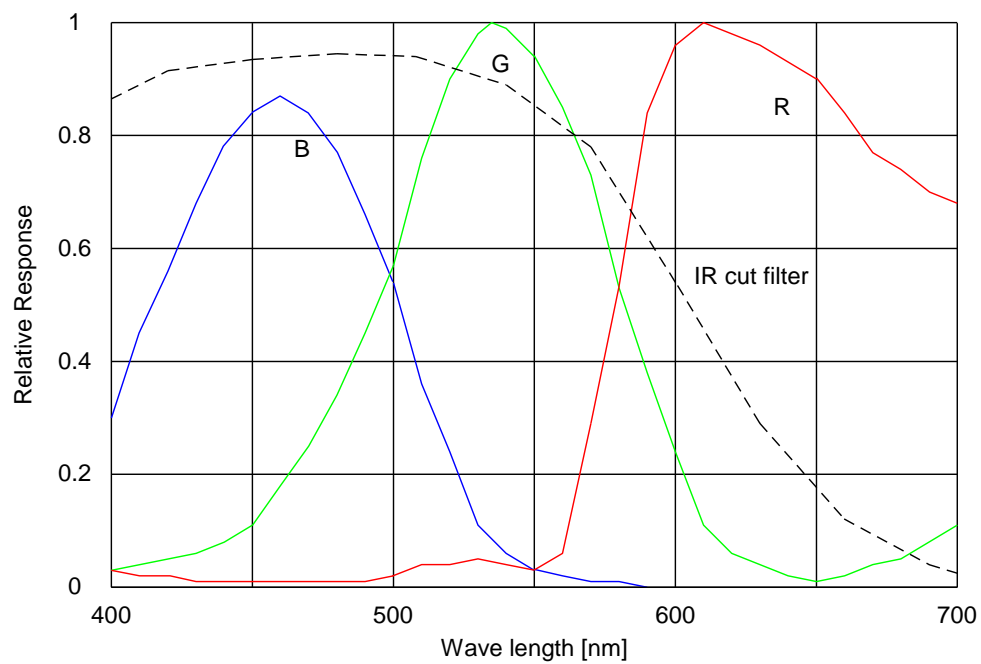

7. STC-SB133POEHS

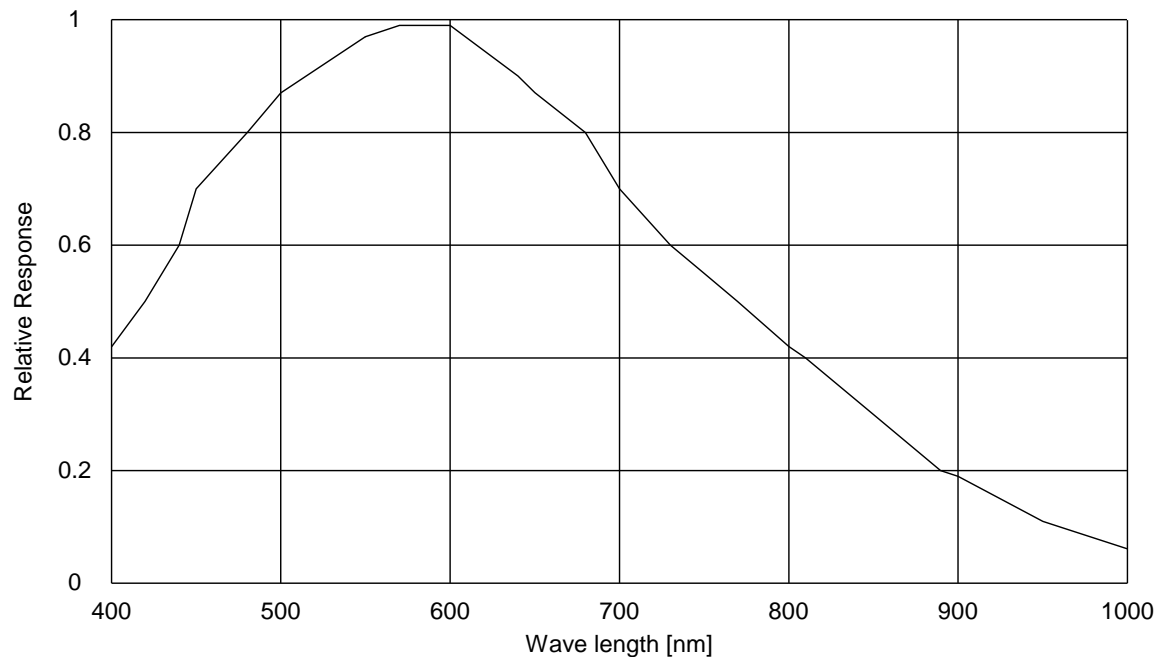

8. STC-SC133POEHS (with IR Cut Filter)

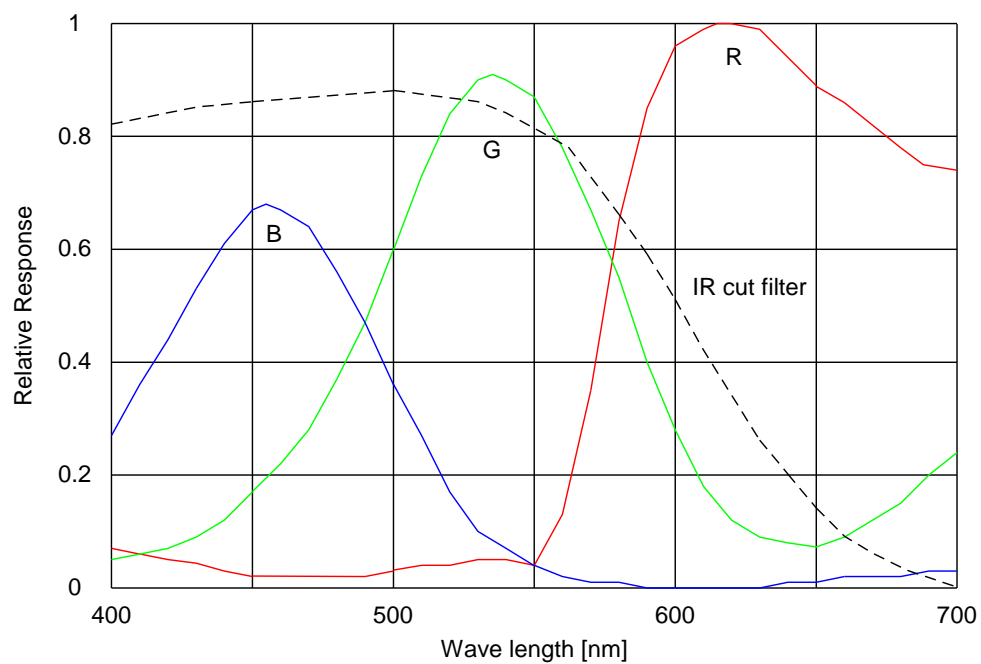

9. STC-SB152POE / STC-SB152POEHS

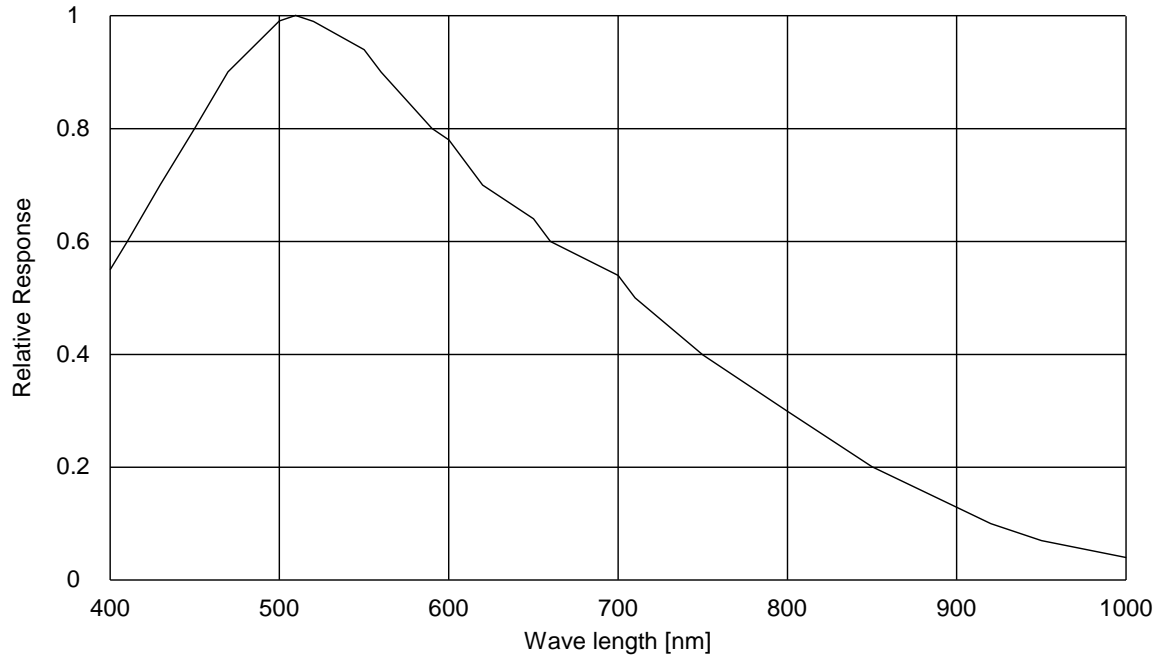

10. STC-SC152POE / STC-SC152POEHS (with IR Cut Filter)

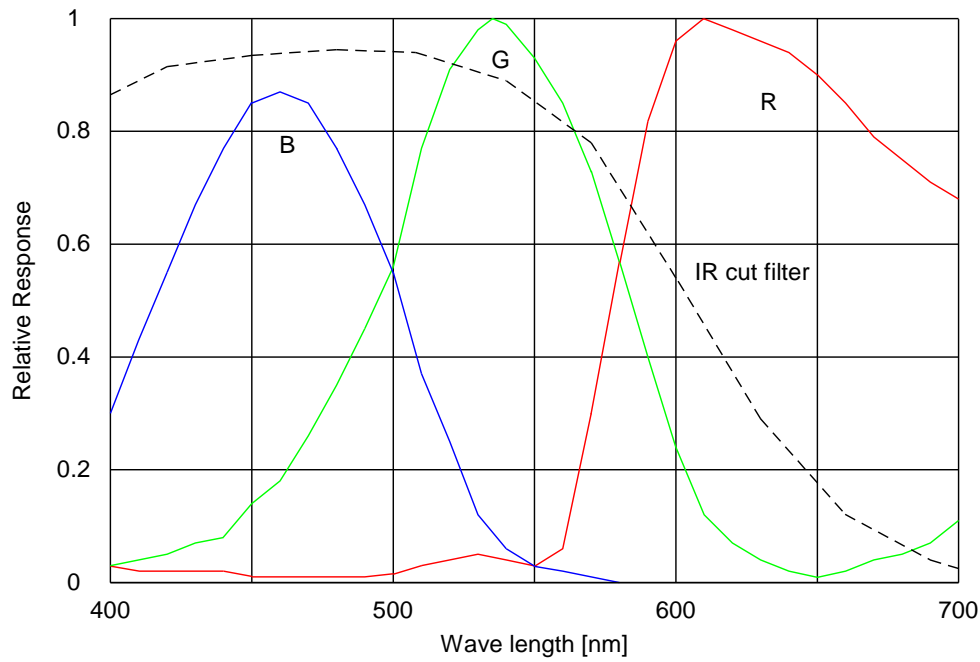

11. STC-SB202POE / STC-SB202POEHS

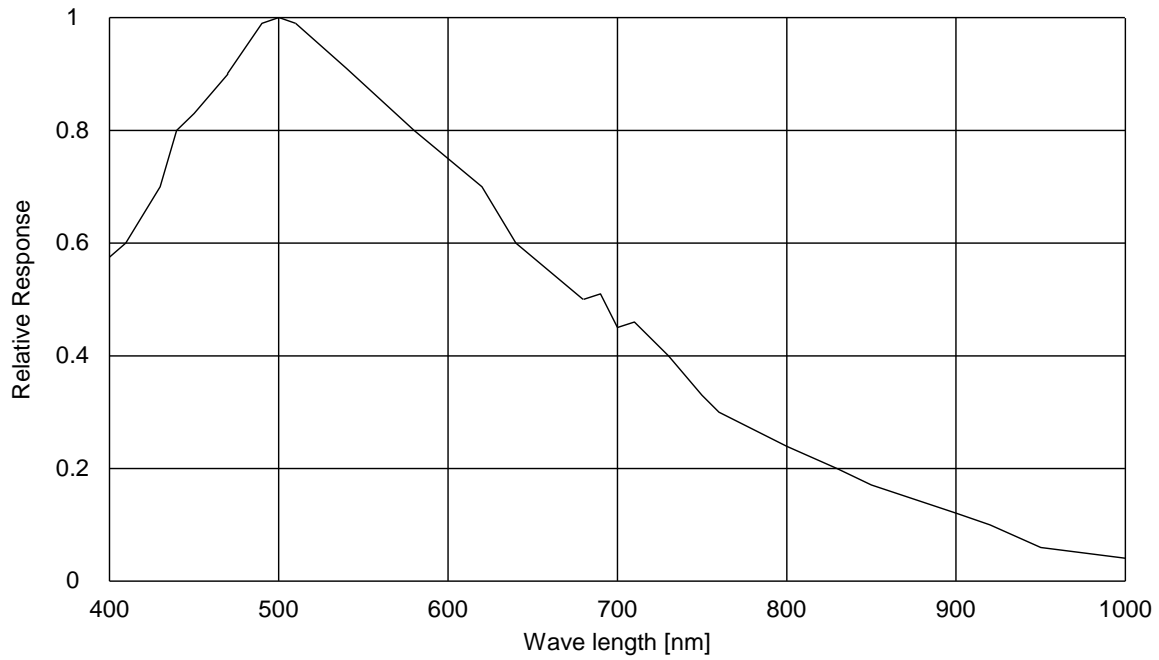

12. STC-SC202POE / STC-SC202POEHS (with IR Cut Filter)

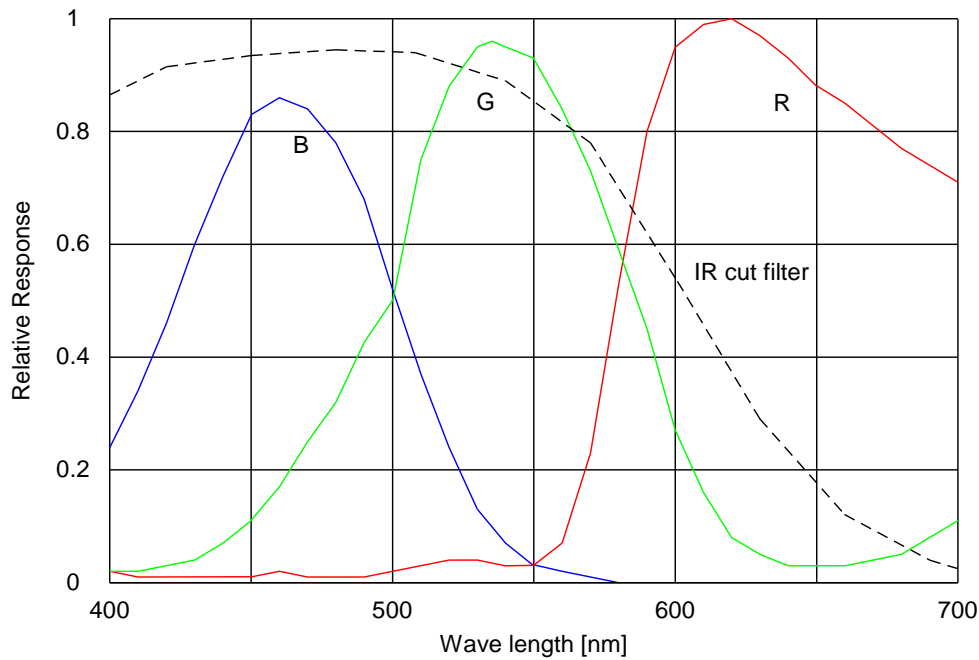

13. STC-SB500POE

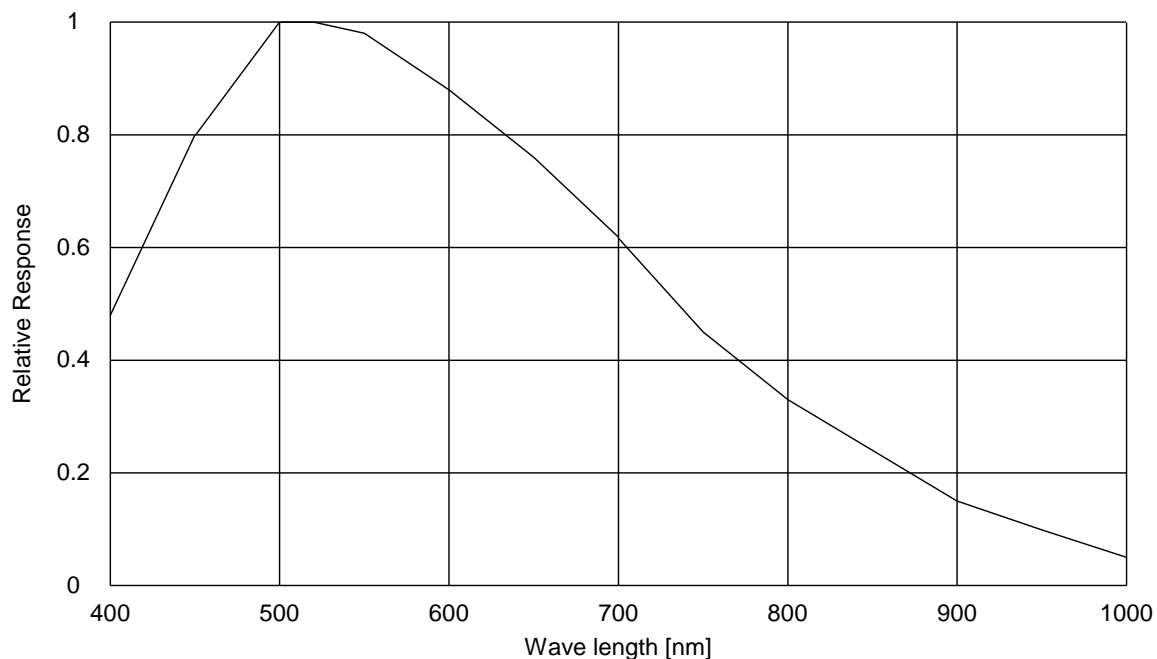

14. STC-SC500POE (with IR Cut Filter)

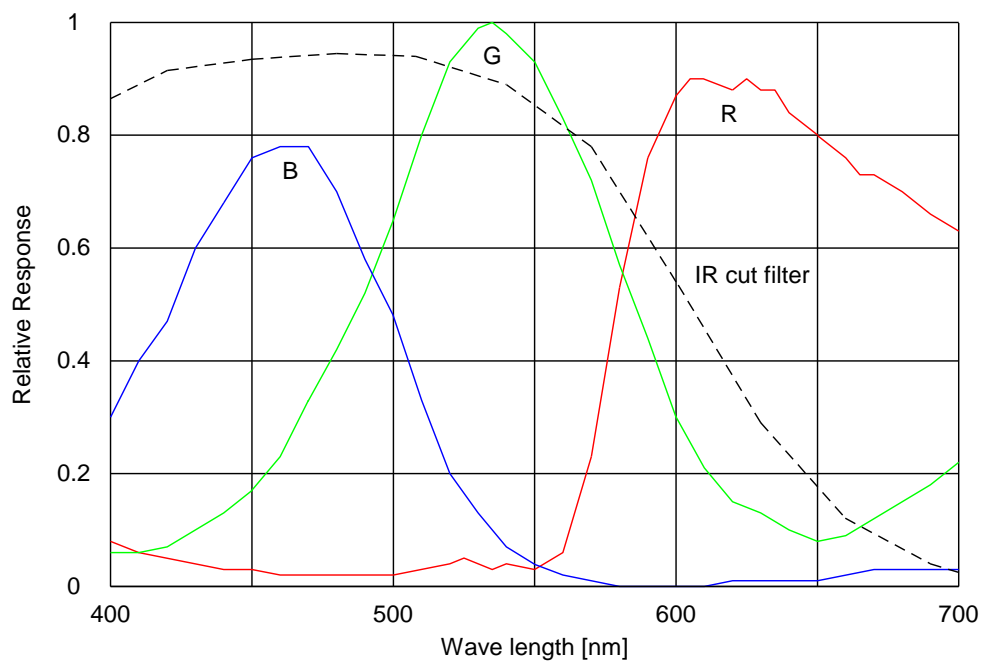

C. Mechanical Specifications

Model Number	STC-SB33POE / STC-SB83POE / TC-SB152POE / STC-SB202POE / STC-SB500POE / STC-SB33POEHS / STC-SB32POEHS / STC-SB133POEHS / STC- SB152POEHS / STC-SB202POEHS	STC-SC33POE / STC-SC83POE / TC-SC152POE / STC-SC202POE / STC-SC500POE / STC-SC33POEHS / STC-SC32POEHS / STC-SC133POEHS / STC- SC152POEHS / STC-SC202POEHS
Dimensions	35 (W) x 35 (H) x 55.9(D) mm excluding connectors	
Optical Filter	No Filter	IR Cut Filter on
Optical Center Accuracy	Positional accuracy in H and V directions: +/- 0.3 mm Rotational accuracy of H and V: +/- 1.5 deg.	
Material	Aluminum (AC)	
Lens Mount	C mount	
Connectors	RJ45 connector Power- I/O connector: HR10A-7R-6PB (Hirose) or equivalent	
Camera Mount Screws	Two 1/4" Tripod screw holes: (One on each top and bottom plate), Twelve M4 screws holes: (Four on each top and bottom plate, two on each side plate)	
Weight	About 130g	

D. Environmental Specifications

Model Number		STC-SB33POE / STC-SC33POE / STC-SB83POE / STC-SC83POE / STC-SB152POE / STC-SC152POE / STC-SB202POE / STC-SC202POE / STC-SB33POEHS / STC-SC33POEHS / STC-SB32POEHS / STC-SC32POEHS / STC-SB133POEHS / STC-SC133POEHS / STC-SB152POEHS / STC-SC152POEHS
Operational Temperature	Minimum	Environmental Temperature -5 ⁰ C
	Maximum	Camera housing temperature (top plate) shall not exceed 65 ⁰ C (This corresponds to an environmental temperature of approximately 40 ⁰ C)
Storage temperature		Environmental Temperature: -30 ⁰ C to 65 ⁰ C
Vibration		20Hz to 200Hz to 20Hz (5min./cycle), acceleration 10G, 3 directions 30 min. each
Shock		Acceleration 38G, half amplitude 6ms, 3 directions 3 times each
Standard Compliancy		EMS: EN61000-6-2, EMI: EN55011
RoHS		RoHS Compliant

Model Number		STC-SB500POE / STC-SC500POE
Operational Temperature	Minimum	Environmental Temperature -5 ⁰ C
	Maximum	Camera housing temperature (top plate) shall not exceed 65 ⁰ C (This corresponds to an environmental temperature of approximately 30 ⁰ C)
Storage temperature		Environmental Temperature: -30 ⁰ C to 65 ⁰ C
Vibration		20Hz to 200Hz to 20Hz (5min./cycle), acceleration 10G, 3 directions 30 min. each
Shock		Acceleration 38G, half amplitude 6ms, 3 directions 3 times each
Standard Compliancy		EMS: EN61000-6-2, EMI: EN55011
RoHS		RoHS Compliant

Model Number		STC-SB202POEHS / STC-SC202POEHS
Operational Temperature	Minimum	Environmental Temperature -5 ⁰ C
	Maximum	Camera housing temperature (top plate) shall not exceed 65 ⁰ C (This corresponds to an environmental temperature of approximately 35 ⁰ C)
Storage temperature		Environmental Temperature: -30 ⁰ C to 65 ⁰ C
Vibration		20Hz to 200Hz to 20Hz (5min./cycle), acceleration 10G, 3 directions 30 min. each
Shock		Acceleration 38G, half amplitude 6ms, 3 directions 3 times each
Standard Compliancy		EMS: EN61000-6-2, EMI: EN55011
RoHS		RoHS Compliant

Note: When the camera is used in a condition that exceeds the maximum environmental temperature specified above, please make sure that the camera is set up to properly radiate heat (maintaining the camera's top case plate's temperature to be less than 65 deg. C).

III. Connector Specifications

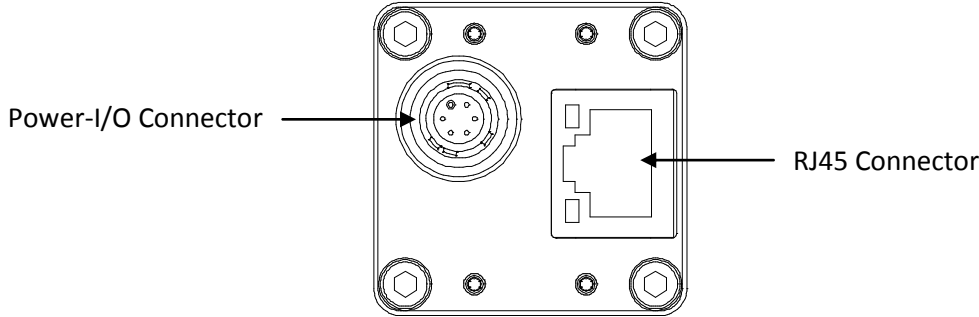

A. RJ45 Connector

This product is PoE compliant. Please supply power through the power-I/O connector when using non-PoE-compliant NIC.

1. Pin Assignment

Pin No.	Signal Name
1	TA+
2	TA-
3	TB+
4	TC+
5	TC-
6	TB-
7	TD+
8	TD-

2. LED Information

Green LED	Yellow LED	Status
Green Light ON	Orange Light ON	Power ON
Green Light ON	Orange Light Blinking	1Gb Transferring
Light OFF	Orange Light Blinking	100 Mb Transferring

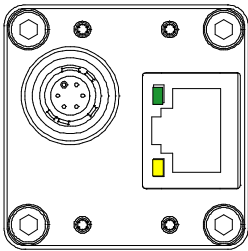

The camera is powered-on

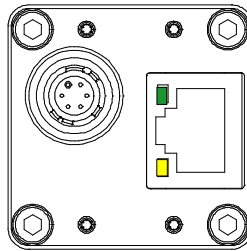

Green light: ON

Yellow light: Blinking

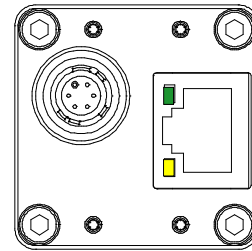

Green light: OFF

Yellow light: Blinking

Please use a 1Gb supported NIC, Network Switcher and LAN Cable. Check that the NIC and Network Switcher being used is “1Gb transferring”.

For further details on the Connection, please see “System Configurations (Example Connections)”.

B. Power-I/O Connector

- HR10A-7R-6PB (Hirose) or equivalent.
- This connector is for the power supply (12Vdc) and input / output signals.
- Use HR10A-7P-6S (Hirose) or equivalent on the cable side.

1. Pin Assignment

Pin No.	Signal Name	IN / OUT	Voltage
1	GND	IN	0V
2	I/O-1	OUT	+3.3V Open Collector
3	I/O-2	OUT	+3.3V Open Collector
4	TRG_In- (Opt. Isolated -)	IN	Low: Smaller than +1.0V High: +3.0 to +26.4V *potential difference between TRG_In- and TRG_In+
5	TRG_In+ (Opt. Isolated +)	IN	
6	POWER IN	IN	+10.8 to +26.4 Vdc

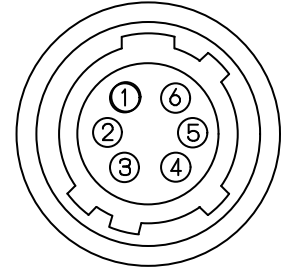

- Output Signals can be assigned through the camera setting communication.
(Device Code = 00H, Command = FOH and F1H)

2. IO Signal Patterns for Pin No. 2 (I/O-1) and Pin No. 3 (I/O-2)

Command No.				HR10A-7R-6PB (Hirose)
FOH[3..0]	F1[3]	FOH[7..4]	F1[4]	I/O-1 (Pin No.2) / I/O-2 (Pin No.3)
For I/O-1 (Pin No. 2)		For I/O-2 (Pin No.3)		
0H (initial setting)	-	0H	-	FrameTriggerWait (initial setting for I/O-1)
1H	Set Value	1H	Set Value	UserOutput
2H	-	2H (initial setting)	-	ExposureActive (initial setting for I/O-2)
3H	-	3H	-	TriggerAuxiliary
4H	-	4H	-	TriggerInternal
5H	-	5H	-	SensorReadOut
6H	-	6H	-	StrobeSignal
7H-FH	-	7H-FH	-	For Test Use Only

Note: I/O-1 can only be assigned by FOH [3..0] and F1[3], and I/O-2 can only be assigned by FOH[7..4] and F1[4].

1) FrameTriggerWait

The user can check the camera condition (camera exposure and image output processing by the trigger signal with this FrameTriggerWait signal).

This signal is LOW for the period from the trigger input signal to the image output.

- a) High status (3.3V): No processing by the trigger signal. The camera accepts the trigger signal.
- b) Low status (0V): The camera is exposed and the image output processes by the trigger signal.

The camera default setting is the input trigger signal is INVALID while at the low status of this signal. When the exposure starts while the image output by the next trigger signal, please change the camera setting (Device code: 00H, Command No. :13H) to accept the trigger signal while the image outputs.

The noise appears on the image when the exposure begins while the image is output. The noise appears on the image when the start exposure while the image is output. In this case, please change the “H reset” for the exposure start mode (Device code: 00H, Command No. : 12H) to change the exposure start point to the next HD timing.

2) UserOutput

The status of the UserOutput signal can change with the “UserOutputValue”.

3) ExposureActive

The user can check the exposure time with the ExposureActive signal.

4) TriggerAuxiliary

The TriggerAuxiliary signal is the input trigger signal.

5) TriggerInternal

The TriggerInternal signal is the input trigger signal with the trigger delay time.

6) SensorReadOut

The SensorReadOut signal is the FVAL signal, which is the image output period of the time.

7) StrobeSignal

The StrobeSignal signal is the strobe control signal.

3. Equivalent Circuit for the Input Pin of the I/O Connector

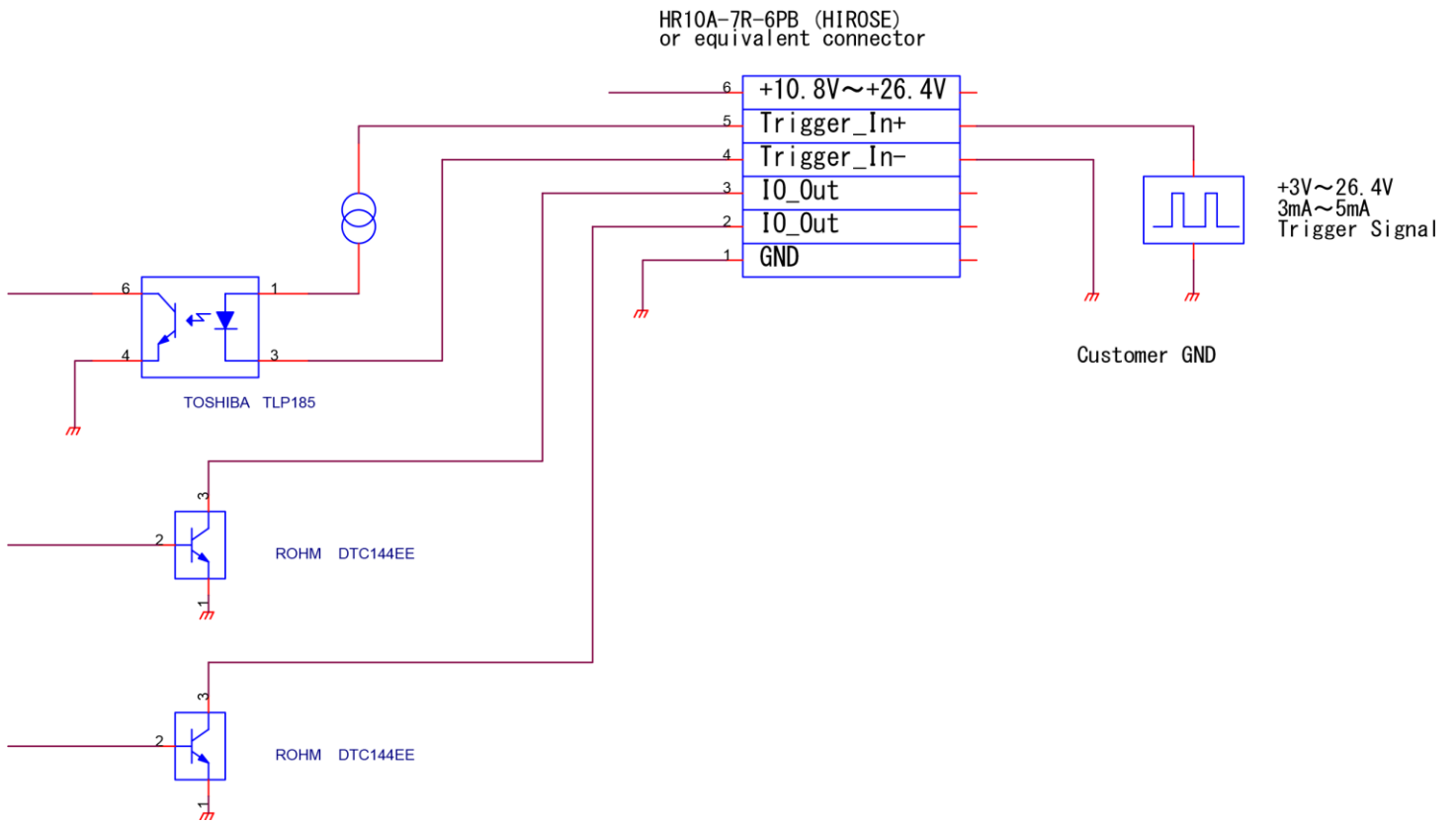

IV. Dimensions

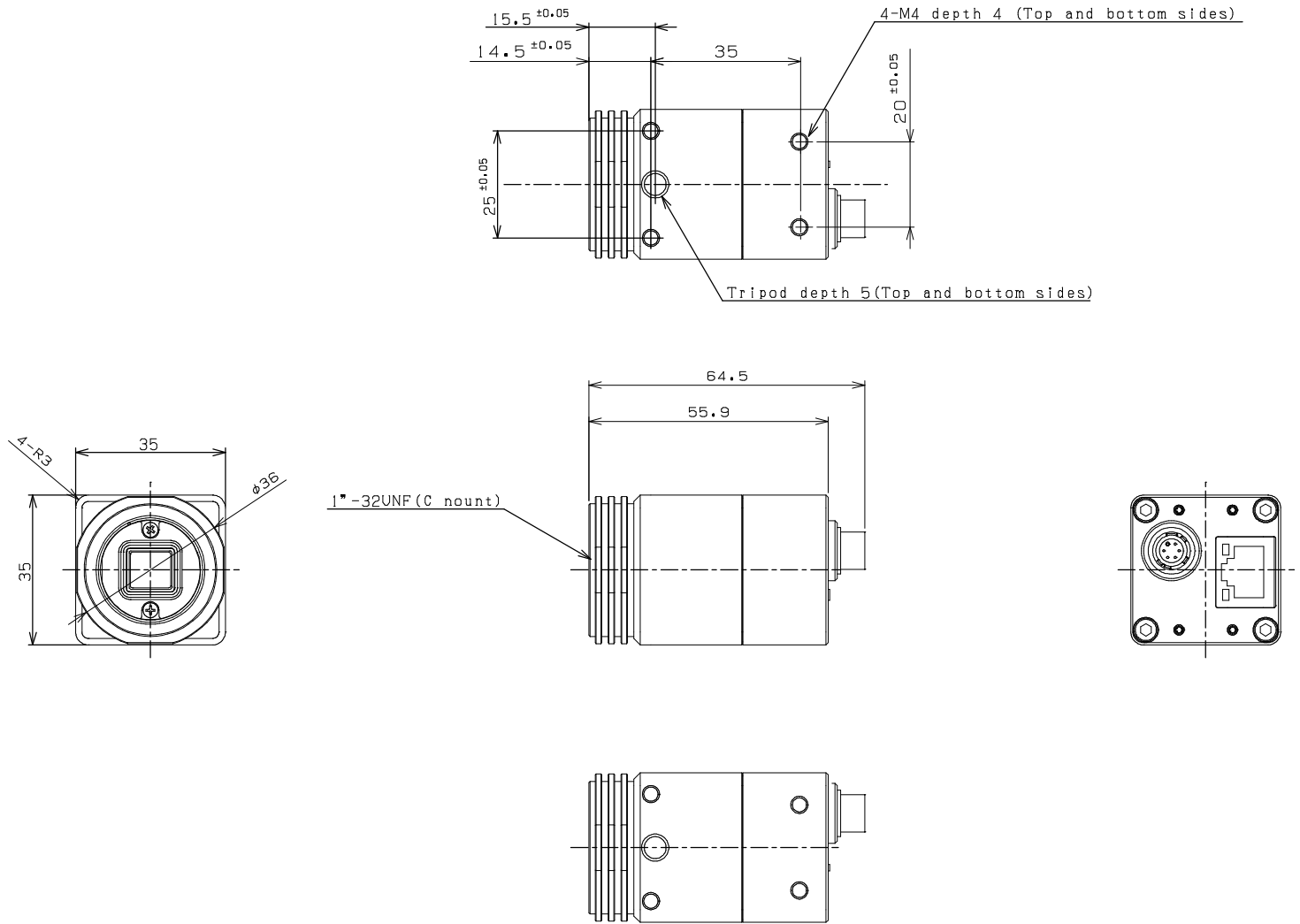

Unit: mm

Revisions

Rev	Date	Changes	Note
1.0	August 13, 2012	New document	
1.02	October 12, 2012	Updated: Vertical Frequency Operational Temperature Power-I/O Pin Assignment Equivalent Circuit for the Input Pin of the I/O Connector	
1.03	December 7, 2012	Updated: Power Consumption, Lux, Description of Exposure Time Pin, IO Signal Patterns, Equivalent Circuit	