



Field Update Line Scan Series

Product Specifications



Features

- High Speed Camera Link Output
- 16K ~ 2K Pixels
- C, F, M42 or M72 Mounts
- Field Update Capability

Safety Precautions

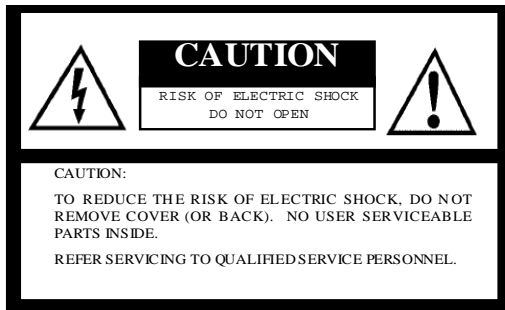

For U.S.A.

Warning:

This equipment generates and uses radio frequency energy and if not installed and used properly, i.e., in strict accordance with the instruction manual, may cause harmful interference to radio communications. It has been tested and found to comply with the limits for a Class A computing device pursuant to Subpart J of Part 15 of FCC Rules, which are designed to provide reasonable protection against such interference when operated in a commercial environment.

For Canada

Warning:

This digital apparatus does not exceed the Class A limits for radio noise emissions from digital apparatus set out in the Radio Interference Regulations of the Canadian Department of Communications.



The lightning flash with arrowhead symbol, within an equilateral triangle, is intended to alert the user to the presence of uninsulated "dangerous voltage" within the product's enclosure that may be of sufficient magnitude to constitute a risk of electric shock to persons.



The exclamation point within an equilateral triangle is intended to alert the user to the presence of important operating and maintenance (servicing) instructions in the literature accompanying the appliance.

WARNING:

TO PREVENT FIRE OR SHOCK HAZARD, DO NOT EXPOSE THIS APPLIANCE TO RAIN OR MOISTURE.

Product Precautions

- Handle the camera with care. Do not abuse the camera. Avoid striking or shaking it. Improper handling or storage could damage the camera.
- Do not pull or damage the camera cable.
- During camera use, do not wrap the unit in any material. This will cause the internal temperature of the unit to increase.
- Do not expose the camera to moisture, or do not try to operate it in wet areas.
- Do not operate the camera beyond its temperature, humidity and power source ratings.
- While the camera is not being used, keep the lens or lens cap on the camera to prevent dust or contamination from getting in the CCD or filter area and scratching or damaging this area.
- Do not keep the camera under the following conditions:
 - In wet, moist, and high humidity areas
 - Under hot direct sunlight
 - In high temperature areas
 - Near an object that releases a strong magnetic or electric field
 - Areas with strong vibrations
- Use a soft cloth to clean the camera. Use pressured air spray to clean the surface of the glass. DO not scratch the surface of the glass.

Copyright & Disclaimer

Sensor Technologies America, Inc. (DBA Sentech America) believes the contents and specifications of its website, catalog, documentation and ads are correct; however, Sentech America provides no representation or warranty regarding such information or product(s) contained therein. It is requested that Sentech America be given appropriate acknowledgement in any subsequent use of such work by a third party.

While every effort has been made to ensure that the details contained in Sentech America's website and all documentation are correct and up-to-date, Sentech America assumes no liability, legal or otherwise for any errors in listings, specifications, part numbers, process, software or model applications. Sentech America reserves the right to change specifications, product descriptions, product quality, pricing and application at any time without prior written or oral notice. Any party using such information assumes all risk for any and all damaged caused to themselves, a third party and/or property by virtue of incorrect information and/or failure of these products. By installing and/or using a Sentech America software development kit or other similar product and/or information obtained from Sentech America's website, catalog, documentation or ads, you hereby accept and understand these stated terms and conditions.

Contents

1. General Specifications.....	7
1.1 Electronic Specifications	7
1.2. Optical Specifications.....	8
1.3. Mechanical Specifications.....	8
1.4. Environmental Specifications	8
2. Product Numbering.....	9
3. Connector Specifications	10
3.1 FS-C2KU7DCL / FS-C4KU7DCL	10
3.2 FS-C8KU7DCL.....	11
3.3 Pin Assignment of the Connectors.....	12
3.3.1 Camera Link Connector (Base): MDR Receptacle (3M)	12
3.3.2. Camera Link Connector (Medium): MDR Receptacle (3M)	12
3.3.3 Power Connector: HR10A-7R-6PB (Hirose or equivalent).....	12
3.4 Bit Assignment	13
3.4.1 FS-C2KU7DCL / FS-C4KU7DCL	13
3.4.2 FS-C4KU7DCL / FS-C8KU7DCL	14
4. Trigger Mode and Exposure Setting	16
4.1 Image Acquisition Control (Trigger and Exposure Timing)	16
5. Pixel Data Output Modes.....	21
5.1 Bayer Filter Pattern on the Sensor.....	21
5.2 Detail of Pixel Data Output Modes	23
5.2.1 Virtual Pixel 1 MODE.....	23
5.2.2 Virtual Pixel 2 MODE.....	24
5.2.3 RAW2 MODE	25
5.2.4 RAW MODE	26
5.2.5 AOI MODE	27
5.2.6 RAW Dual Line MODE	28
6. Video Output Formats	29
6.1 Video Output Format of FS-C2KU7DCL.....	29
6.1.1 8 bit x 3 tap RGB (Virtual Pixel 1)	30
6.1.2 10 bit x 3 tap RGB (Virtual Pixel 1)	30

6.1.3	8 bit x 3 tap RGB (Virtual Pixel 2)	30
6.1.4	10 bit x 3 tap RGB (Virtual Pixel 2)	31
6.1.5	8 bit x 4 tap RAW Color	31
6.1.6	10 bit x 4 tap RAW Color	31
6.1.7	8 bit x 4 tap RAW Direct	32
6.1.8	10 bit x 4 tap RAW Direct	32
6.1.9	8 bit x 8 tap RAW	32
6.1.10	10 bit x 2 tap RAW Direct	33
6.2.	Video Output format of FS-C4KU7DCL	34
6.2.1	8 bit x 6 tap RGB (Virtual Pixel 1)	36
6.2.2	8 bit x 3 tap RGB (Virtual Pixel 1)	37
6.2.3	10 bit x 3 tap RGB (Virtual Pixel 1)	37
6.2.4	8 bit x 6 tap RGB (Virtual Pixel 2)	38
6.2.5	8 bit x 3 tap RGB (Virtual Pixel 2)	38
6.2.6	10 bit x 3 tap RGB (Virtual Pixel 2)	39
6.2.7	8 bit x 8 tap RAW Color	39
6.2.8	10 bit x 8 tap RAW Color	40
6.2.9	8 bit x 4 tap RAW Color	40
6.2.10	10 bit x 4 tap RAW Color	40
6.2.11	8 bit x 8 tap RAW Direct	41
6.2.12	8 bit x 4 tap RAW Direct	42
6.2.13	10 bit x 4 tap RAW Direct	42
6.2.14	8 bit x 2 tap RAW Direct	42
6.2.15	10 bit x 2 tap RAW Direct	43
6.2.16	8 bit x 8 tap Raw Dual Line	43
6.3.	Video Output Format of FS-C8KU7DCL	44
6.3.1	8 bit x 6 tap RGB (Virtual Pixel 1)	45
6.3.2	8 bit x 3 tap RGB (Virtual Pixel 1)	45
6.3.3	10 bit x 3 tap RGB (Virtual Pixel 1)	46
6.3.4	8 bit x 6 tap RGB (Virtual Pixel 2)	46
6.3.5	8 bit x 3 tap RGB (Virtual Pixel 2)	47
6.3.6	10 bit x 3 tap RGB (Virtual Pixel 2)	47
6.3.7	8 bit x 8 tap RAW COLOR	48
6.3.8	10 bit x 8 tap RAW COLOR	49

- 6.3.9 8 bit x 4 tap RAW COLOR 49
- 6.3.10 10 bit x 4 tap RAW COLOR 49
- 6.3.11 8 bit x 8 tap RAW Direct..... 50
- 6.3.12 8 bit x 4 tap RAW Direct..... 51
- 6.3.13 10 bit x 4 tap RAW Direct..... 51
- 6.3.14 8 bit x 2 tap RAW Direct..... 51
- 6.3.15 10 bit x 2 tap RAW Direct..... 52
- 6.3.16 8 bit x 8 tap RAW Dual Line..... 52
- 7. Details of Camera Control..... 53
 - 7.1 Field Flat Correction (FFC)..... 53
 - 7.1.1 Summary of FFC 53
 - 7.1.2 Technical Terminology 53
 - 7.1.3 Auto FFC Procedure 54
 - 7.1.4 Manual FFC Procedure..... 57
 - 7.1.5 Confirm FFC..... 57
 - 7.1.6 Save FFC 57
 - 7.1.7 FFC Corrected Value Store Mode 58
- 8. The Communication Protocol Specifications 59
 - 8.1 The Communication Method..... 59
 - 8.2 The Communication Settings 59
 - 8.3 The Communication Format 59
 - 8.4 The Camera Control Commands..... 62
 - 8.4.1 The Camera Command List 62
 - 8.4.2 Camera Command Descriptions 63
 - 8.4.3 Save the Camera Setting Data into FLASH..... 69
 - 8.4.4 Sequence of Camera Power On 69
- 9. Control Software Manual..... 70
 - 9.1 Control Software 70
 - 9.2 Summary 70
 - 9.2.1 File 71
 - 9.2.2 Common..... 71
 - 9.2.3 Mode..... 72
 - 9.2.4 Help 72
 - 9.3 Standard Tab..... 73

9.3.1 Basic	73
9.3.2 FFC 74	
9.3.3 Chattering	80
10. Field Update Function.....	82
10.1 Procedure.....	82
11. Quantum Efficiency.....	83
12. Dimensions.....	84
12.1 FS-C2KU7DCL-C	84
12.2 FS-C2KU7DCL-F	85
12.3 FS-C4KU7DCL-F	86
12.4 FS-C8KU7DCL-M72.....	87

1. General Specifications

1.1 Electronic Specifications

		FS-C2KU7DCLU	FS-C4KU7DCLU	FS-C8KU7DCLU
Image sensor		2k CMOS image sensor DR-2X2K-7-inver- RGB(AWAIBA)	4k CMOS image sensor DR-2X4K-7-inver-RGB (AWAIBA)	8k CMOS image sensor DR-2X8K-7- RGB(AWAIBA)
Active pixels		2,048 pixels x 2lines(Bayer)	4,096 pixels x 2lines(Bayer)	8,192 pixels x 2lines(Bayer)
Pixel size		7(H) x 7(V)um (7um pitch)		
Photo array length		14.336 mm	28.672 mm	57.344 mm
data rate		85MHz x3tap(RGB) 80MHz x3tap(RGB) 50MHz x3tap(RGB) *Note1	85MHz x6tap(RGBx2) *Note2 80MHz x6tap(RGBx2) 50MHz x6tap(RGBx2) 85MHz x3tap(RGB) 80MHz x3tap(RGB) 50MHz x3tap(RGB)	85MHz x6tap(RGBx2) 80MHz x6tap(RGBx2) 50MHz x6tap(RGBx2) 85MHz x3tap(RGB) 80MHz x3tap(RGB) 50MHz x3tap(RGB)
Maximum line rate		80kHz (85MHz x3tap(RGB)) 75kHz (80MHz x3tap(RGB)) 46kHz (50MHz x3tap(RGB))	80.5kHz(85MHz x6tap(RGBx2)) 75kHz (80MHz x6tap(RGBx2)) 46kHz (50MHz x6tap(RGBx2)) 40.5kHz (85MHz x3tap(RGB)) 38.5kHz (80MHz x3tap(RGB)) 24kHz (50MHz x3tap(RGB))	40.5kHz(85MHzx6tap(RGBx2)) 38.5kHz(80MHzx6tap(RGBx2)) 24kHz (50MHzx6tap(RGBx2)) 20.5kHz (85MHz x3tap(RGB)) 19kHz (80MHz x3tap(RGB)) 12kHz (50MHz x3tap(RGB))
Video output		Camera Link Base/Medium configuration (8/10bit)	Camera Link Base/Medium/Full configuration (8/10bit)	
Power	Input voltage	+12 Vdc to +24 Vdc		
	Consumption	6.0 W(typ)	6.0 W(typ)	7.5W(typ)
Communication		RS232C via Camera Link connector		
Functions		Anti-blooming High speed exposure control External trigger control Flat Field Correction(FFC)		

*Note 1: Virtual Pixel 1

*Note 2: Virtual Pixel 2

1.2. Optical Specifications

Product	FS-C2KU7DCL	FS-C4KU7DCL	FS-C8KU7DCL
Fill Factor	100%		
Responsivity	77DN/nj/cm2		

1.3. Mechanical Specifications

Product	FS-C2KU7DCL	FS-C4KU7DCL	FS-C8KU7DCL
Dimensions	56(W) x 58(H) x 26.5(D) mm		80(W) x 100(H) x 38.1(D) mm (excluding the connector)
Lens mount	F mount, C mount	F mount	M72 mount(P=0.75mm)
Weight	about 198g		about 472g
Interface connectors	Camera Link connector (MDR) x2 Power connector (6pin connector)		
Operation temperature	0 to 40 deg. C		

1.4. Environmental Specifications

Product	FS-C2KU7DCL	FS-C4KU7DCL	FS-C8KU7DCL
RoHS	RoHS compliance		
Operating temperature	0 to 40 deg. C		
Storage temperature	-30 to 65 deg. C		

2. Product Numbering

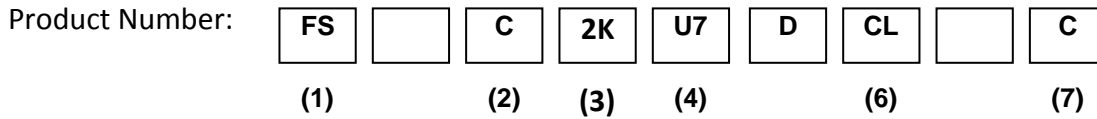

- (1). Series
- (2). Monochrome / Color
 - B: Monochrome
 - C: Color
- (3). Number of Pixels
 - 16: 16K
 - 8: 8K
 - 4: 4K
 - 2: 2K
- (4). Pixel Size
 - U14: 14 um
 - U35: 3.5um
 - U7: 7um
- (5). Line Number
 - None: 1 line (single)
 - D: 2 lines (dual)
 - Q: 4 lines (quad)
- (6). Output Type
 - CL: Camera Link
 - GE: GigE Vision
- (7). Mount Type
 - C: C Mount
 - F: F Mount
 - M72: M72 Mount

Model Number	Description
FS-C2KU7DCL-C	Color bayer 2048pixs, C-mount
FS-C2KU7DCL-F	Color bayer 2048pixs, F-mount
FS-C4KU7DCL-F	Color bayer 4096pixs, F-mount
FS-C8KU7DCL-M72	Color bayer 8192pixs, M72-mount

3. Connector Specifications

3.1 FS-C2KU7DCL / FS-C4KU7DCL

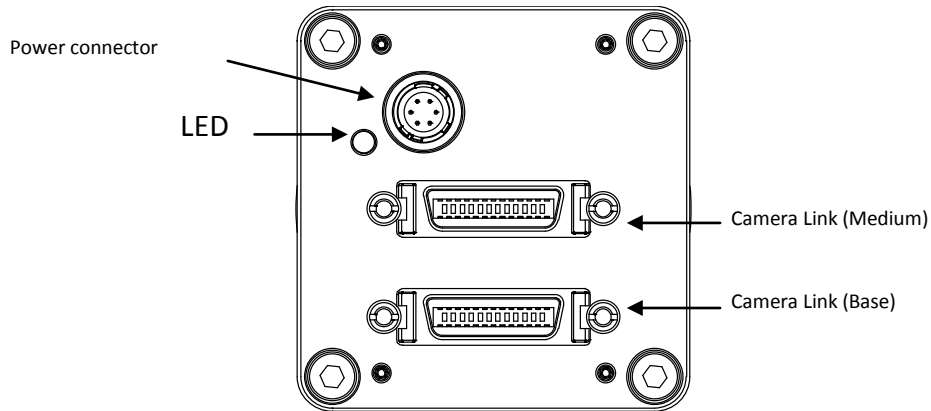

1. Camera Link (Base): MDR Receptacle (3M)
2. Camera Link (Medium): MDR Receptacle (3M)
3. Power Connector: HR10A-7R-6PB (Hirose or Equivalent)
This connector is for +12to +24Vdc power input.
The LED will display RED light when the power is on.

3.2 FS-C8KU7DCL

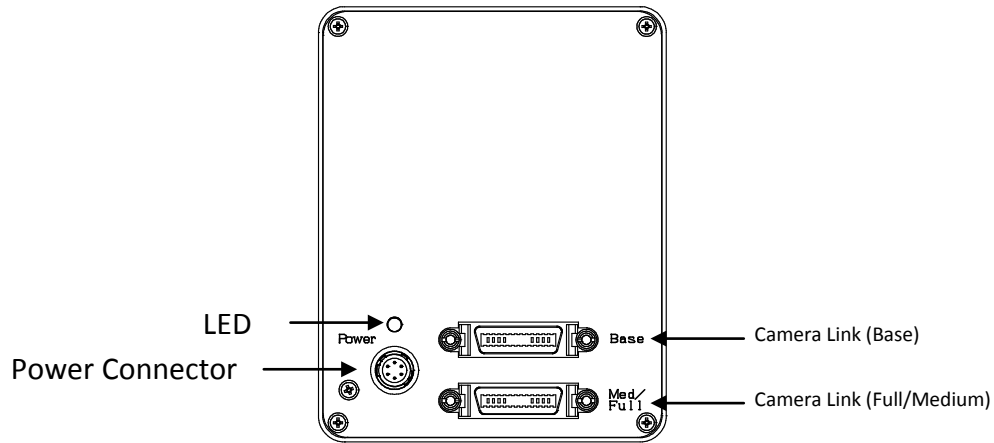

1. Camera Link Connector (Base): MDR Receptacle (3M)
2. Camera Link Connector (Full / Medium): MDR Receptacle (3M)
3. Power Connector: HR10A-7R-6PB (Hirose or Equivalent)
This connector is for +12 to +24Vdc power input.
The LED will display RED light when the power is on.

3.3 Pin Assignment of the Connectors

3.3.1 Camera Link Connector (Base): MDR Receptacle (3M)

Pin No.	Signal name	Pin No.	Signal name
1	GND	14	GND
2	X0-	15	X0+
3	X1-	16	X1+
4	X2-	17	X2+
5	Xclk-	18	Xclk+
6	X3-	19	X3+
7	SerTC+	20	SerTC-
8	SerTFG-	21	SerTFG+
9	CC1- (for the external sync signal input)	22	CC1+ (for the external sync signal input)
10	CC2+	23	CC2-
11	CC3-	24	CC3+
12	CC4+	25	CC4-
13	GND	26	GND

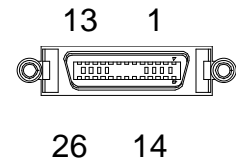

3.3.2. Camera Link Connector (Medium): MDR Receptacle (3M)

Pin No.	Signal name	Pin No.	Signal name
1	GND	14	GND
2	Y0-	15	Y0+
3	Y1-	16	Y1+
4	Y2-	17	Y2+
5	Yclk-	18	Yclk+
6	Y3-	19	Y3+
7	100 Ohm terminated	20	100 Ohm terminated
8	Z0-	21	Z0+
9	Z1-	22	Z1+
10	Z2-	23	Z2+
11	Zclk-	24	Zclk+
12	Z3-	25	Z3+
13	GND	26	GND

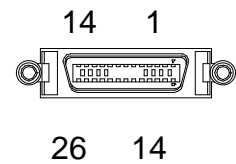

signal name	I/O	explanation
CC1	I	Ext TRG. As for the detail, please refer to the section 4.
CC2	-	Spare
CC3	-	Spare
CC4	-	Spare
SerTC	I	Serial communication from the frame grabber.
SerTFG	O	Serial communication to the frame grabber.

3.3.3 Power Connector: HR10A-7R-6PB (Hirose or equivalent)

Pin No.	Signal name	IN/OUT	Voltage
1	+12 V	IN	+12 V to +24V
2	+12 V	IN	+12 V to +24V
3	+12 V	IN	+12 V to +24V
4	GND		
5	GND		
6	GND		

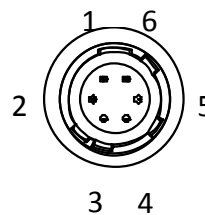

3.4 Bit Assignment

3.4.1 FS-C2KU7DCL / FS-C4KU7DCL

8 bit x 3 tap

Base Configuration(Base connector)			
Port/bit	8-bit x 2taps	Port/bit	8-bit x 2taps
Port A0	A0	Port C0	C0
Port A1	A1	Port C1	C1
Port A2	A2	Port C2	C2
Port A3	A3	Port C3	C3
Port A4	A4	Port C4	C4
Port A5	A5	Port C5	C5
Port A6	A6	Port C6	C6
Port A7	A7	Port C7	C7
Port B0	B0		
Port B1	B1		
Port B2	B2		
Port B3	B3		
Port B4	B4		
Port B5	B5		
Port B6	B6		
Port B7	B7		

10 bit x 3 tap

Base connector			
Port/bit	10-bit x 3taps	Port/bit	10-bit x 3taps
Port A0	A0	Port C0	B0
Port A1	A1	Port C1	B1
Port A2	A2	Port C2	B2
Port A3	A3	Port C3	B3
Port A4	A4	Port C4	B4
Port A5	A5	Port C5	B5
Port A6	A6	Port C6	B6
Port A7	A7	Port C7	B7
Port B0	A8		
Port B1	A9		
Port B2	nc		
Port B3	nc		
Port B4	B8		
Port B5	B9		
Port B6	nc		
Port B7	nc		

Medium connector			
Port/bit	10-bit x 3taps	Port/bit	10-bit x 4taps
Port D0	nc	Port F0	C8
Port D1	nc	Port F1	C9
Port D2	nc	Port F2	nc
Port D3	nc	Port F3	nc
Port D4	nc	Port F4	nc
Port D5	nc	Port F5	nc
Port D6	nc	Port F6	nc
Port D7	nc	Port F7	nc
Port E0	C0		
Port E1	C1		
Port E2	C2		
Port E3	C3		
Port E4	C4		
Port E5	C5		
Port E6	C6		
Port E7	C7		

Note: For the actual output data timing, please refer to the section VI-A (Video Output Format)

3.4.2 FS-C4KU7DCL / FS-C8KU7DCL

8 bit x 6 tap (opck=0,1,8,11,13,14,21)

Base connector			
Port/bit	8-bit x 6	Port/bit	8-bit x 6
Port A0	A0	Port C0	C0
Port A1	A1	Port C1	C1
Port A2	A2	Port C2	C2
Port A3	A3	Port C3	C3
Port A4	A4	Port C4	C4
Port A5	A5	Port C5	C5
Port A6	A6	Port C6	C6
Port A7	A7	Port C7	C7
Port B0	B0		
Port B1	B1		
Port B2	B2		
Port B3	B3		
Port B4	B4		
Port B5	B5		
Port B6	B6		
Port B7	B7		

Medium connector					
Port/bit	8-bit x 6	Port/bit	8-bit x 6	Port/bit	8-bit x 6
Port D0	D0	Port F0	F0	Port H0	nc
Port D1	D1	Port F1	F1	Port H1	nc
Port D2	D2	Port F2	F2	Port H2	nc
Port D3	D3	Port F3	F3	Port H3	nc
Port D4	D4	Port F4	F4	Port H4	nc
Port D5	D5	Port F5	F5	Port H5	nc
Port D6	D6	Port F6	F6	Port H6	nc
Port D7	D7	Port F7	F7	Port H7	nc
Port E0	E0	Port G0	nc		
Port E1	E1	Port G1	nc		
Port E2	E2	Port G2	nc		
Port E3	E3	Port G3	nc		
Port E4	E4	Port G4	nc		
Port E5	E5	Port G5	nc		
Port E6	E6	Port G6	nc		
Port E7	E7	Port G7	nc		

8 bit x 3 tap (opck=2,3,9,15,16,22)

Base connector			
Port/bit	8-bit x 2taps	Port/bit	8-bit x 2taps
Port A0	A0	Port C0	C0
Port A1	A1	Port C1	C1
Port A2	A2	Port C2	C2
Port A3	A3	Port C3	C3
Port A4	A4	Port C4	C4
Port A5	A5	Port C5	C5
Port A6	A6	Port C6	C6
Port A7	A7	Port C7	C7
Port B0	B0		
Port B1	B1		
Port B2	B2		
Port B3	B3		
Port B4	B4		
Port B5	B5		
Port B6	B6		
Port B7	B7		

10 bit x 3 tap(opck=2,3,9,15,16,22)

Base connector			
Port/bit	10-bit x 3taps	Port/bit	10-bit x 3taps
Port A0	A0	Port C0	B0
Port A1	A1	Port C1	B1
Port A2	A2	Port C2	B2
Port A3	A3	Port C3	B3
Port A4	A4	Port C4	B4
Port A5	A5	Port C5	B5
Port A6	A6	Port C6	B6
Port A7	A7	Port C7	B7
Port B0	A8		
Port B1	A9		
Port B2	nc		
Port B3	nc		
Port B4	B8		
Port B5	B9		
Port B6	nc		
Port B7	nc		

Medium connector			
Port/bit	10-bit x 3taps	Port/bit	10-bit x 4taps
Port D0	nc	Port F0	C8
Port D1	nc	Port F1	C9
Port D2	nc	Port F2	nc
Port D3	nc	Port F3	nc
Port D4	nc	Port F4	nc
Port D5	nc	Port F5	nc
Port D6	nc	Port F6	nc
Port D7	nc	Port F7	nc
Port E0	C0		
Port E1	C1		
Port E2	C2		
Port E3	C3		
Port E4	C4		
Port E5	C5		
Port E6	C6		
Port E7	C7		

Note: For the actual output data timing, please refer to the section VI-B (Video Output Format)

4. Trigger Mode and Exposure Setting

Caution:

Camera does not accept any command without sync signal. When External Trigger Mode (limd=1) is used through Hyper Terminal, please sent the commands on Internal Sync mode. And send the next command after receiving OK.

4.1 Image Acquisition Control (Trigger and Exposure Timing)

EXT LINE

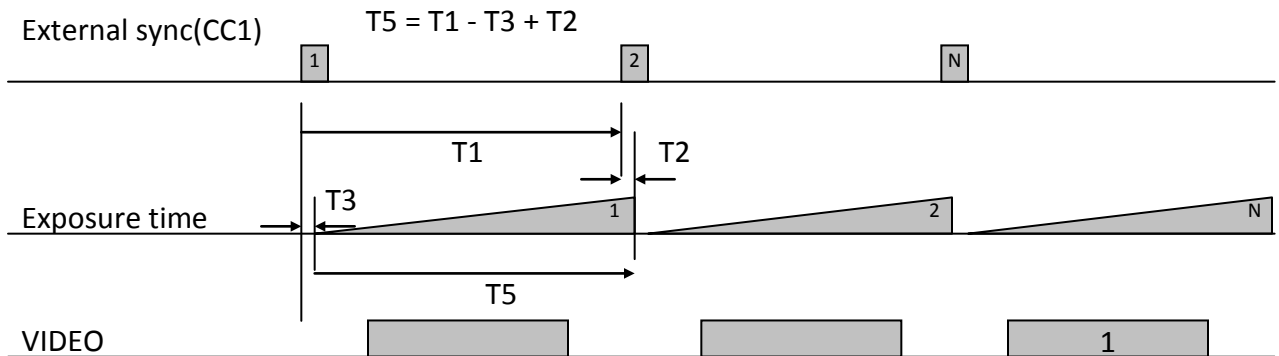

EXT FIX MODE

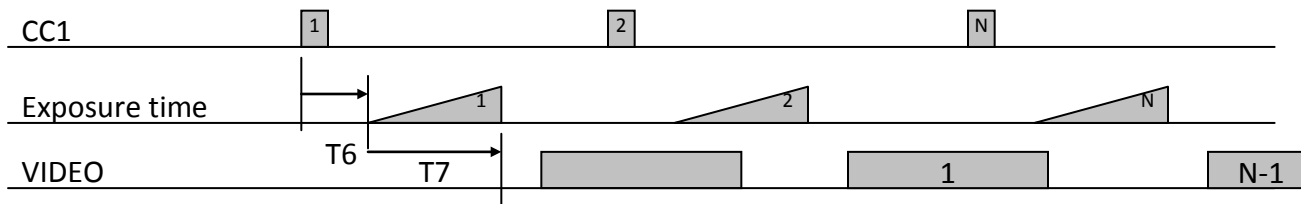

PULSE MODE

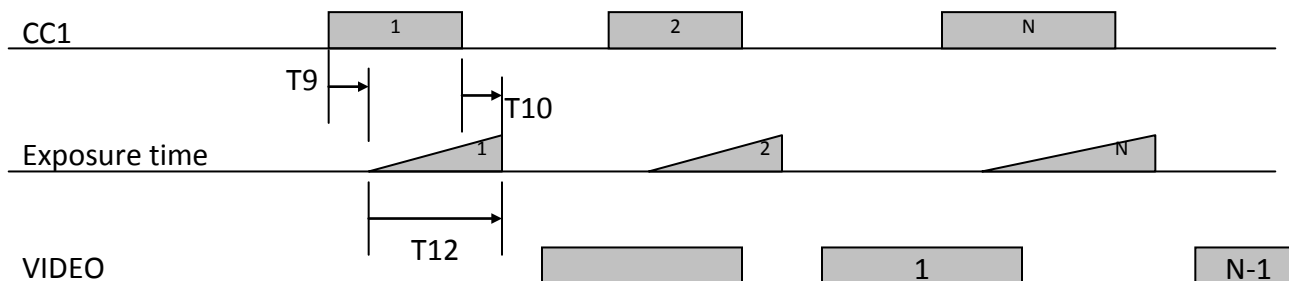

INTERNAL MODE

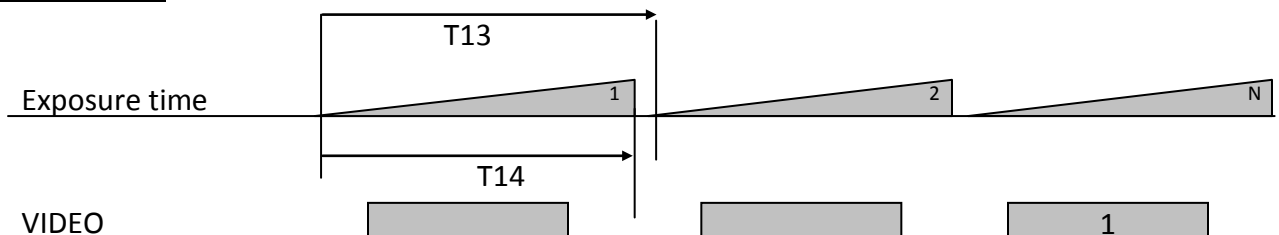

The actual time for each timing is shown in the table below.

[clk] = 11.8ns

For the detailed commands, please refer to section VII-E (Command List)

opck: Get Data Rate Mode

intu: Get the exposure time

intl: Get the exposure time

Label	Description	value
T1	Line interval	External sync : CC1 line period
T2	Sync rise to exposure end	6[clk]+1[us]
T3	Sync rise to exposure start	18[clk]+3[us]
T5	Exposure time (EXT_LINE_MODE)	$T5 = T1 - T3 + T2 = T1 - (18[clk]+3[us]) + (6[clk]+1[us])$ $= T1 - 12[clk] - 2[us]$
T6	CC1 rise to exposure start (EXT_FIX_MODE)	6[clk] + 2[us]
T7	Exposure time (EXT_FIX)	$(intu * 256 + intl) * 0.2[us] + 2[us]$ min setting : intu = 0, intl = 0 Maximum Exposure Time: Line period - 3us
T9	CC1 rise to exposure start PULSE)	5[clk] + 2[us]
T10	CC1 fall to exposure end PULSE)	5 [clk] + 1[us]
T12	Exposure time (PULSE_MODE)	Pulse width of CC1 -1[us]
T13	Line interval (INTERNAL_MODE)	FS-C2KU7DCLU Output mode(EH)=0: $(intu * 256 + intl) * 0.2[us] + 13.2[us]$ Output mode(EH)=1: $(intu * 256 + intl) * 0.2[us] + 21.1[us]$ Output mode(EH)=8: $(intu * 256 + intl) * 0.2[us] + 13.2[us]$ Output mode(EH)=11: $(intu * 256 + intl) * 0.2[us] + 12.5[us]$ Output mode(EH)=13: $(intu * 256 + intl) * 0.2[us] + 24.5[us]$ Output mode(EH)=14: $(intu * 256 + intl) * 0.2[us] + 41.5[us]$ Output mode(EH)=21: $(intu * 256 + intl) * 0.2[us] + 26.0[us]$ FS-C4KU7DCLU Output mode(EH)=0: $(intu * 256 + intl) * 0.2[us] + 13.2[us]$ Output mode(EH)=1: $(intu * 256 + intl) * 0.2[us] +$

		<p>21.1[us]</p> <p>Output mode(EHh)=2: $(intu * 256 + intl) * 0.2[us] + 24.5[us]$</p> <p>Output mode(EHh)=3: $(intu * 256 + intl) * 0.2[us] + 41.6[us]$</p> <p>Output mode(EHh)=8: $(intu * 256 + intl) * 0.2[us] + 13.2[us]$</p> <p>Output mode(EHh)=9: $(intu * 256 + intl) * 0.2[us] + 26.0[us]$</p> <p>Output mode(EHh)=11: $(intu * 256 + intl) * 0.2[us] + 12.5[us]$</p> <p>Output mode(EHh)=13: $(intu * 256 + intl) * 0.2[us] + 24.5[us]$</p> <p>Output mode(EHh)=14: $(intu * 256 + intl) * 0.2[us] + 41.5[us]$</p> <p>Output mode(EHh)=15: $(intu * 256 + intl) * 0.2[us] + 48.6[us]$</p> <p>Output mode(EHh)=16: $(intu * 256 + intl) * 0.2[us] + 82.6[us]$</p> <p>FS-C8KU7DCL</p> <p>Output mode(EHh)=1: $(intu * 256 + intl) * 0.4[us] + 41.6[us]$</p> <p>Output mode(EHh)=2: $(intu * 256 + intl) * 0.4[us] + 48.5[us]$</p> <p>Output mode(EHh)=3: $(intu * 256 + intl) * 0.4[us] + 82.5[us]$</p> <p>Output mode(EHh)=4: $(intu * 256 + intl) * 0.4[us] + 24.8[us]$</p> <p>Output mode(EHh)=5: $(intu * 256 + intl) * 0.4[us] + 41.6[us]$</p> <p>Output mode(EHh)=8: $(intu * 256 + intl) * 0.4[us] + 26.0[us]$</p> <p>Output mode(EHh)=9: $(intu * 256 + intl) * 0.4[us] + 51.6[us]$</p> <p>Output mode(EHh)=10: $(intu * 256 + intl) * 0.4[us] + 26.0[us]$</p> <p>Output mode(EHh)=11: $(intu * 256 + intl) * 0.4[us] +$</p>
--	--	---

	<p>24.8[us]</p> <p>Output mode(EHh)=13: $(intu * 256 + intl) * 0.4[us] + 48.5[us]$</p> <p>Output mode(EHh)=14: $(intu * 256 + intl) * 0.4[us] + 82.5[us]$</p> <p>Output mode(EHh)=15: $(intu * 256 + intl) * 0.4[us] + 96.7[us]$</p> <p>Output mode(EHh)=16: $(intu * 256 + intl) * 0.4[us] + 164.4[us]$</p> <p>Output mode(EHh)=21: $(intu * 256 + intl) * 0.4[us] + 51.6[us]$</p> <p>Output mode(EHh)=22: $(intu * 256 + intl) * 0.4[us] + 102.8[us]$</p> <p>Output mode(EHh)=24: $(intu * 256 + intl) * 0.4[us] + 26.0[us]$</p> <p>Output mode(EHh)=25: $(intu * 256 + intl) * 0.4[us] + 41.6[us]$</p> <p>Output mode(EHh)=27: $(intu * 256 + intl) * 0.4[us] + 26.0[us]$</p> <p>Output mode(EHh)=28: $(intu * 256 + intl) * 0.4[us] + 41.6[us]$</p> <p>Output mode(EHh)=32: $(intu * 256 + intl) * 0.4[us] + 48.5[us]$</p> <p>Output mode(EHh)=33: $(intu * 256 + intl) * 0.4[us] + 51.6[us]$</p> <p>Output mode(EHh)=34: $(intu * 256 + intl) * 0.4[us] + 82.5[us]$</p> <p>Output mode(EHh)=35: $(intu * 256 + intl) * 0.4[us] + 24.8[us]$</p> <p>Output mode(EHh)=36: $(intu * 256 + intl) * 0.4[us] + 26.0[us]$</p> <p>Output mode(EHh)=37: $(intu * 256 + intl) * 0.4[us] + 41.6[us]$</p> <p>Output mode(EHh)=38: $(intu * 256 + intl) * 0.4[us] + 48.5[us]$</p> <p>Output mode(EHh)=39: $(intu * 256 + intl) * 0.4[us] + 51.6[us]$</p> <p>Output mode(EHh)=40: $(intu * 256 + intl) * 0.4[us] + 82.5[us]$</p> <p>Output mode(EHh)=41: $(intu * 256 + intl) * 0.4[us] + 96.7[us]$</p> <p>Output mode(EHh)=42: $(intu * 256 + intl) * 0.4[us] + 102.8[us]$</p>
--	---

		<p>Output mode(EH)=43: $(intu * 256 + intl) * 0.4[us] + 164.4[us]$</p> <p>Output mode(EH)=48: $(intu * 256 + intl) * 0.4[us] + 26.0[us]$</p> <p>Output mode(EH)=49: $(intu * 256 + intl) * 0.4[us] + 41.6[us]$</p> <p>Output mode(EH)=51: $(intu * 256 + intl) * 0.4[us] + 26.0[us]$</p> <p>Output mode(EH)=52: $(intu * 256 + intl) * 0.4[us] + 41.6[us]$</p> <p>Output mode(EH)=59: $(intu * 256 + intl) * 0.4[us] + 83.1[us]$</p>
T14	Exposure time (INTERNAL_MODE)	$T13 - 2[us] - 12[clk]$

5. Pixel Data Output Modes

5.1 Bayer Filter Pattern on the Sensor

- There are two lines on the sensor.
- Line 1 has Red and Green pixels, whereas Line 2 has Green and Blue pixels as a Bayer pattern.
- There is no gap on Line 1 and Line 2
- The "green" value for pixel 1 in line 1 is (Gr1), the "green" value for pixel 1 in line 2 is (Gb1).

Figure of Bayer Filter Pattern

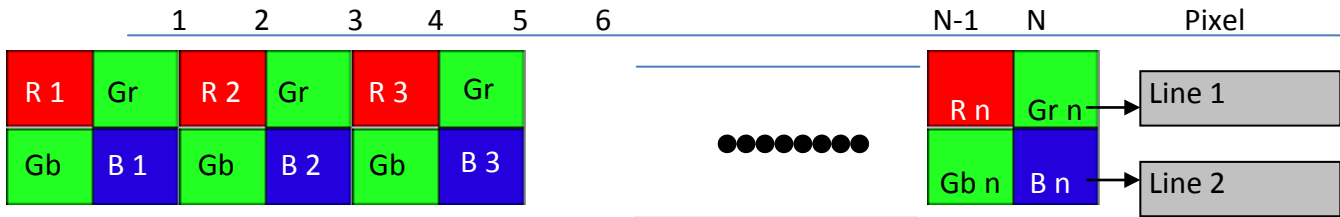

	FS-C2KU7DCL	FS-C4KU7DCL	FS-C8KU7DCL
N	2048	4096	8192
n	1024	2048	4096

- R = Red Pixel
- Gr = Green Pixel on Line 1
- Gb = Green Pixel on Line 2
- B = Blue Pixel

Sensor Line Location

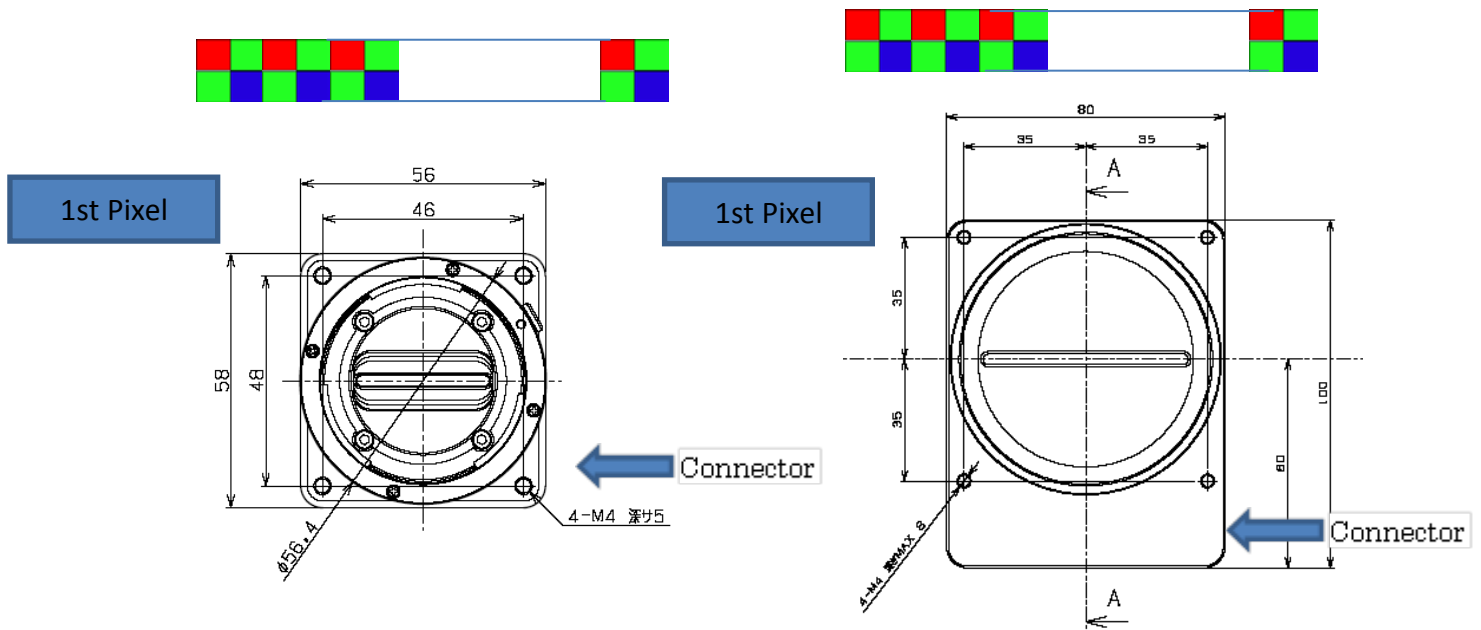

Object Direction

Camera outputs one pixel data from several sensor data except opck=23,24,25. Therefore the object direction does not matter. Both directions should work. As for the opck=23,24,25. Object should move from top to bottom.

5.2 Detail of Pixel Data Output Modes

5.2.1 Virtual Pixel 1 MODE

- This mode outputs over 3 Camera Link ports. The image is N pixels Bayer pattern sensor.
- In 3 TAP mode, Pixel data reads out from left to right on the sensor, and outputs over 3 Camera Link ports.
- In 6 tap mode, Pixel data reads out from left to center and center to right on the sensor, and outputs over 6 Camera Link ports.
- Green is the average value of Gr and Gb for Camera Link port.

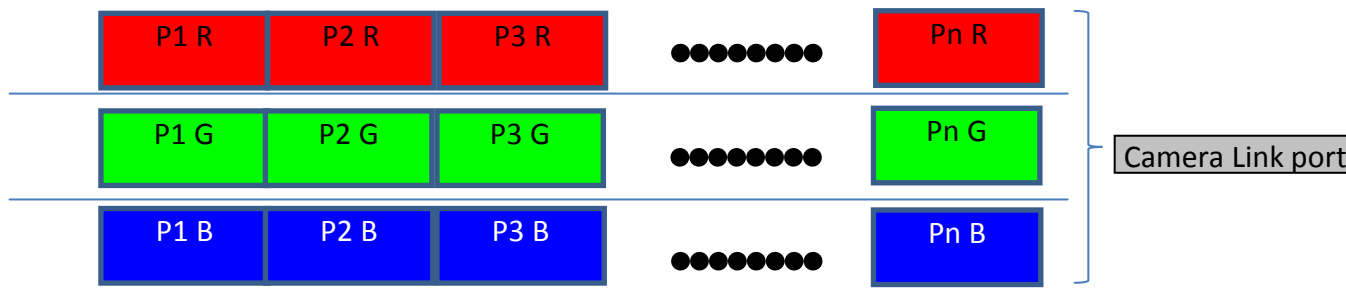
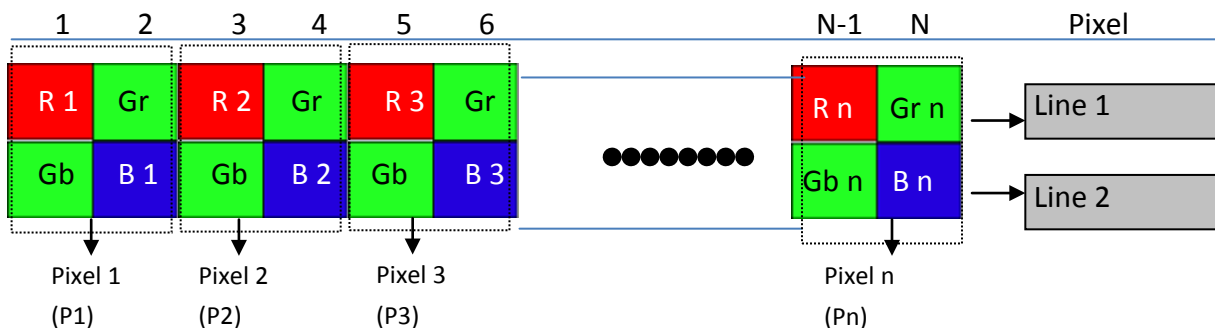

	FS-C2KU7DCL	FS-C4KU7DCL	FS-C8KU7DCL
N	2048	4096	8192
n	1024	2048	4096

- R = Red Pixel
- Gr = green Pixel on Line1
- Gb = Green Pixel on Line2
- B = Blue Pixel
- G = Average of Gr, Gb

5.2.2 Virtual Pixel 2 MODE

This mode outputs over 3 Camera Link ports.

Only 3 TAP mode.

Green on a Camera Link port is an average value of Gr, Gb.

The last pixel (Pixel (N)) must not be used for the non-pixel value used on the calculations.

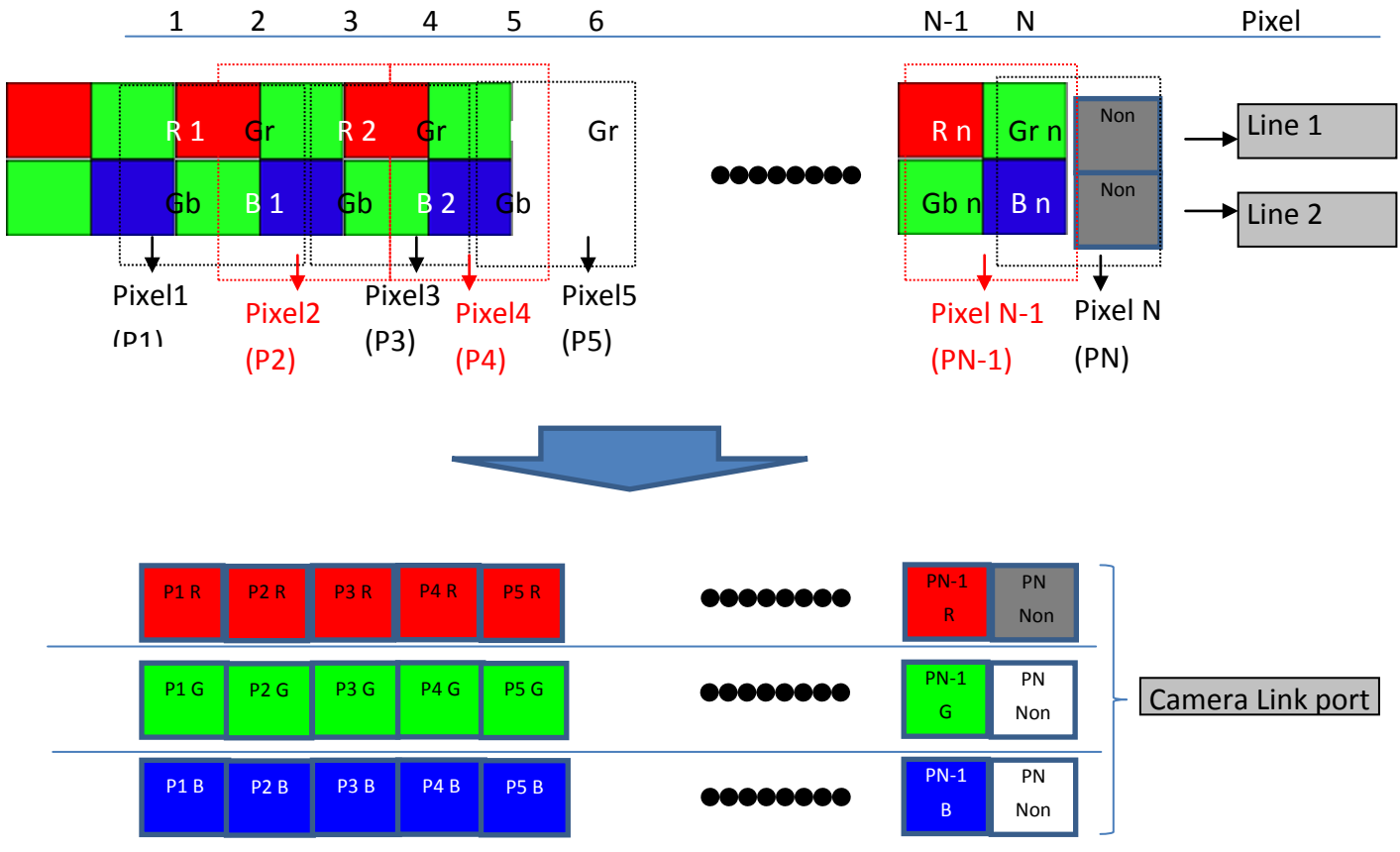

	FS-C2KU7DCL	FS-C4KU7DCL	FS-C8KU7DCL
N	2048	4096	8192
n	1024	2048	4096

- R = Red pixel
- Gr = Green Pixel on Line1
- Gb = Green Pixel on Line2
- B = Blue Pixel
- G = Average of Gr,Gb

5.2.3 RAW2 MODE

This mode outputs over 4 Camera Link ports (4TAP) from Bayer pattern sensor.

In 4 TAP mode, Pixel data reads out for left to center. In 8TAP, Pixel data reads out from left to center and center to right on the sensor.

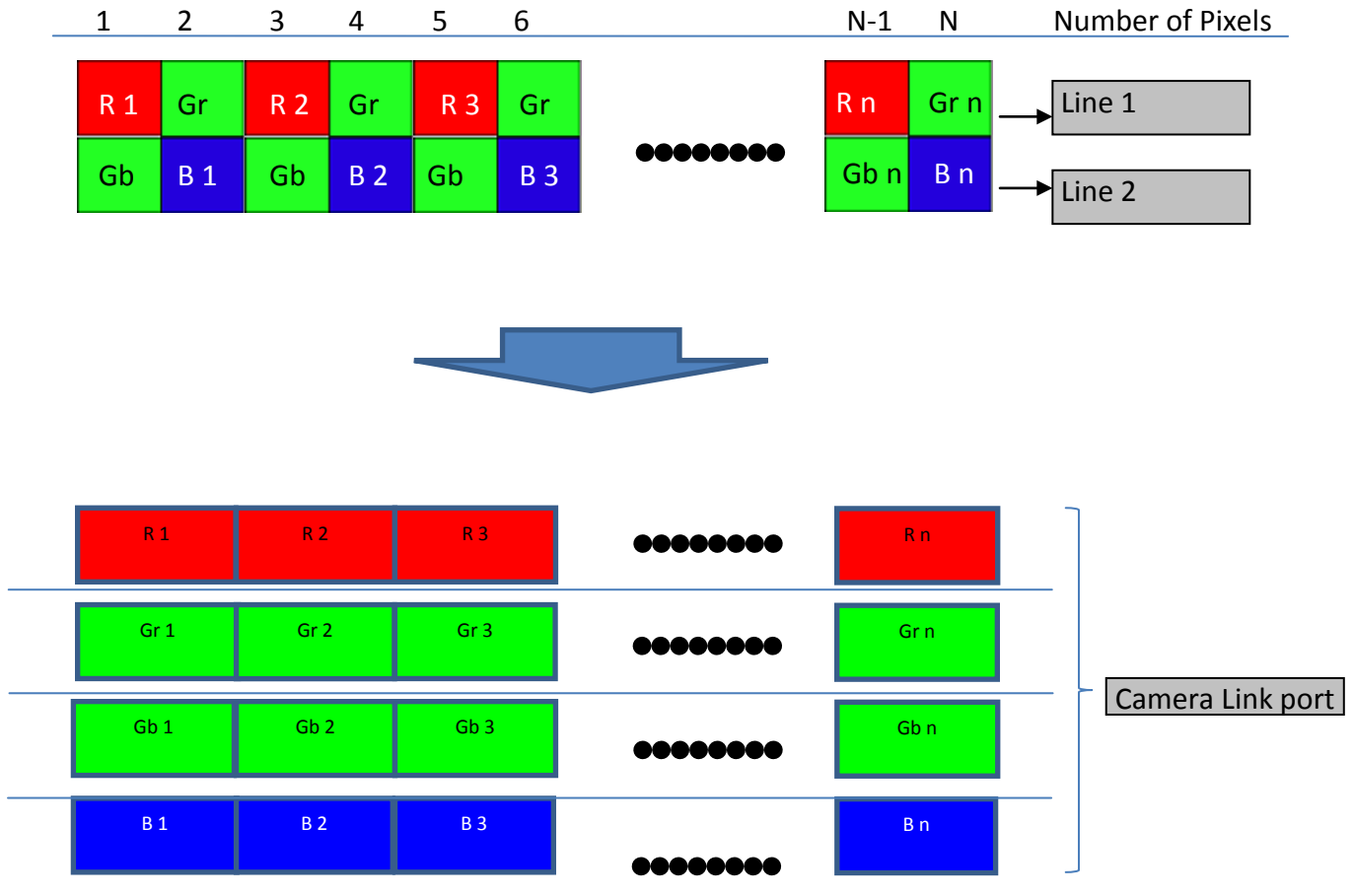

	FS-C2KU7DCL	FS-C4KU7DCL	FS-C8KU7DCL
N	2048	4096	8192
n	1024	2048	4096

- R = Red Pixel
- Gr = Green Pixel on Line1
- Gb = Green Pixel on Line2
- B = Blue Pixel

5.2.4 RAW MODE

This mode outputs over 2 Camera Link ports (2TAP) from Bayer pattern sensor.

In 2TAP mode, Pixel data reads out from left to center. In 4TAP, Pixel data reads out from left to center and center to right on the sensor.

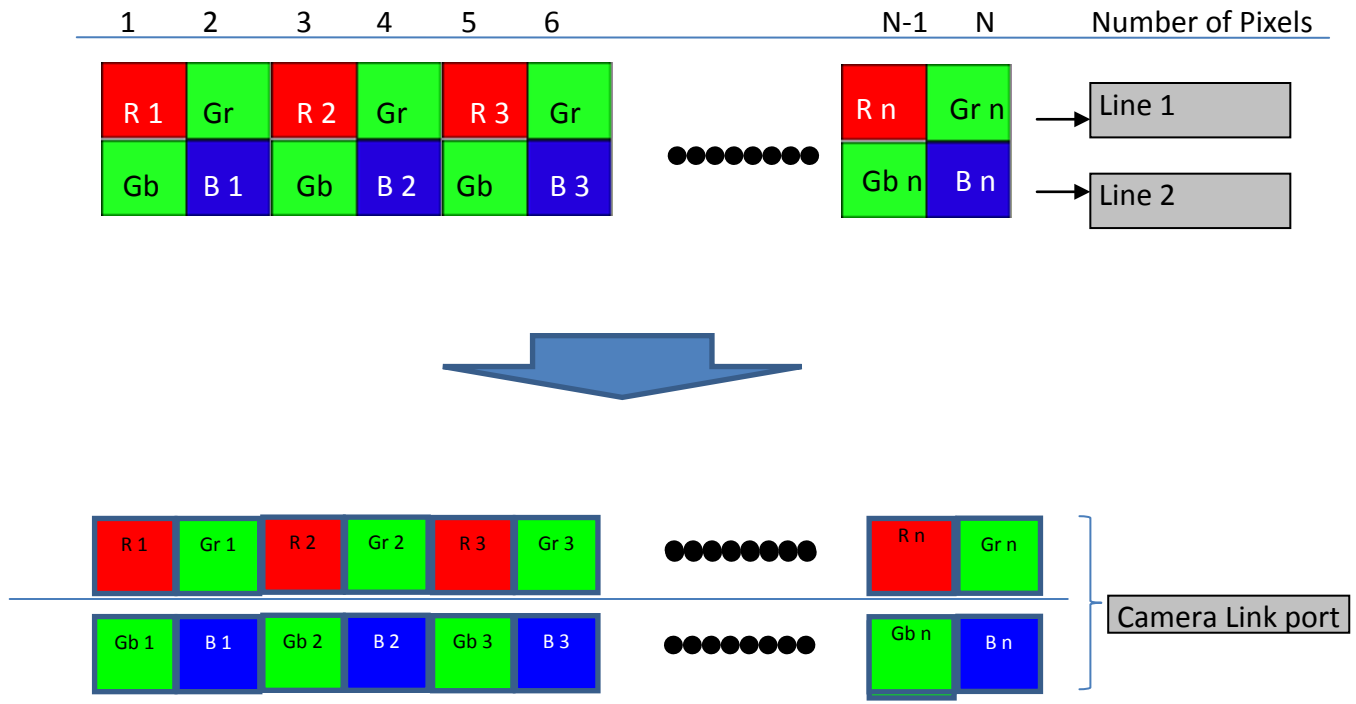

	FS-C2KU7DCL	FS-C4KU7DCL	FS-C8KU7DCL
N	2048	4096	8192
n	1024	2048	4096

- R = Red Pixel
- Gr = Green Pixel on Line1
- Gb = Green Pixel on Line2
- B = Blue Pixel

5.2.5 AOI MODE

Area of Interest image should be output.

Through the start pixel of video output and Width of LVAL setting, AOI can be output for each output mode.

Start pixel of video output can be set through command risu/risl.

Width of LVAL can be set through command riwu/riwl.

risu: Get Data Rate Mode

risl: Get the exposure time

riwu: Get the length of LVAL (The upper rank)

riwl: Get the length of LVAL (The lower rank)

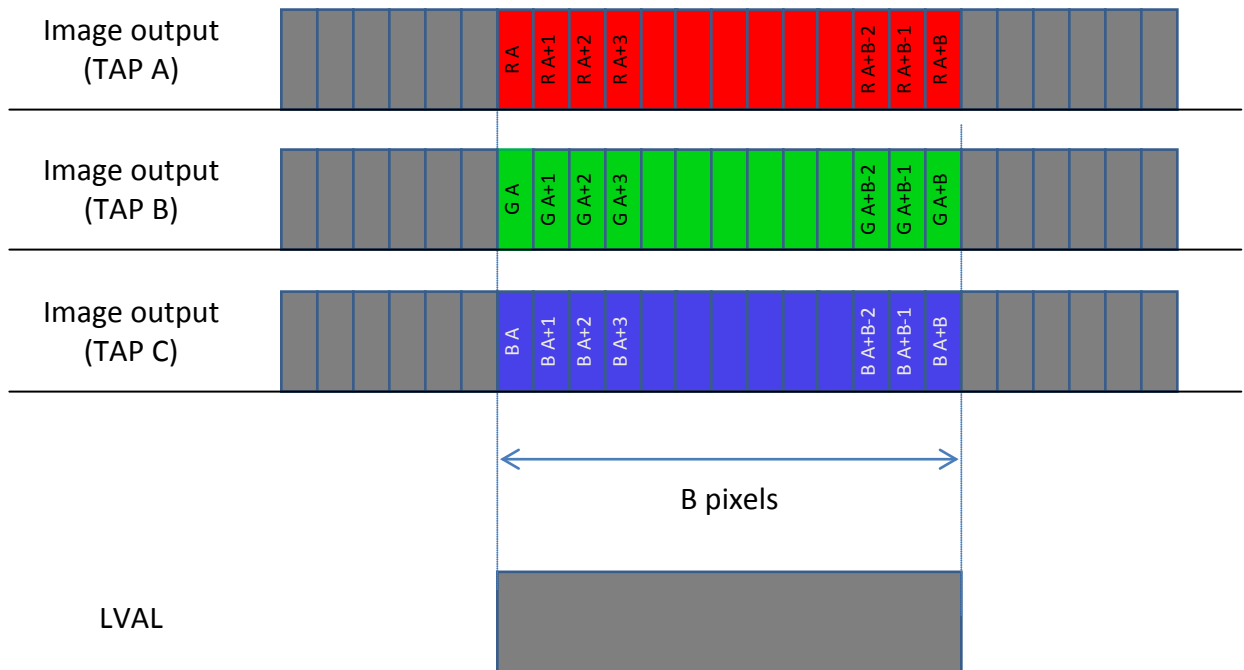

Offset : A Pixel

$$A = (risu \times 256) + risl$$

Width of AOI: B Pixels

$$B = (riwu \times 256) + riwl$$

R = Red Pixel

Gr = Green Pixel on Line1

Gb = Green Pixel on Line2

B = Blue Pixel

5.2.6 RAW Dual Line MODE

This mode is compatible with Basler (Line A First)

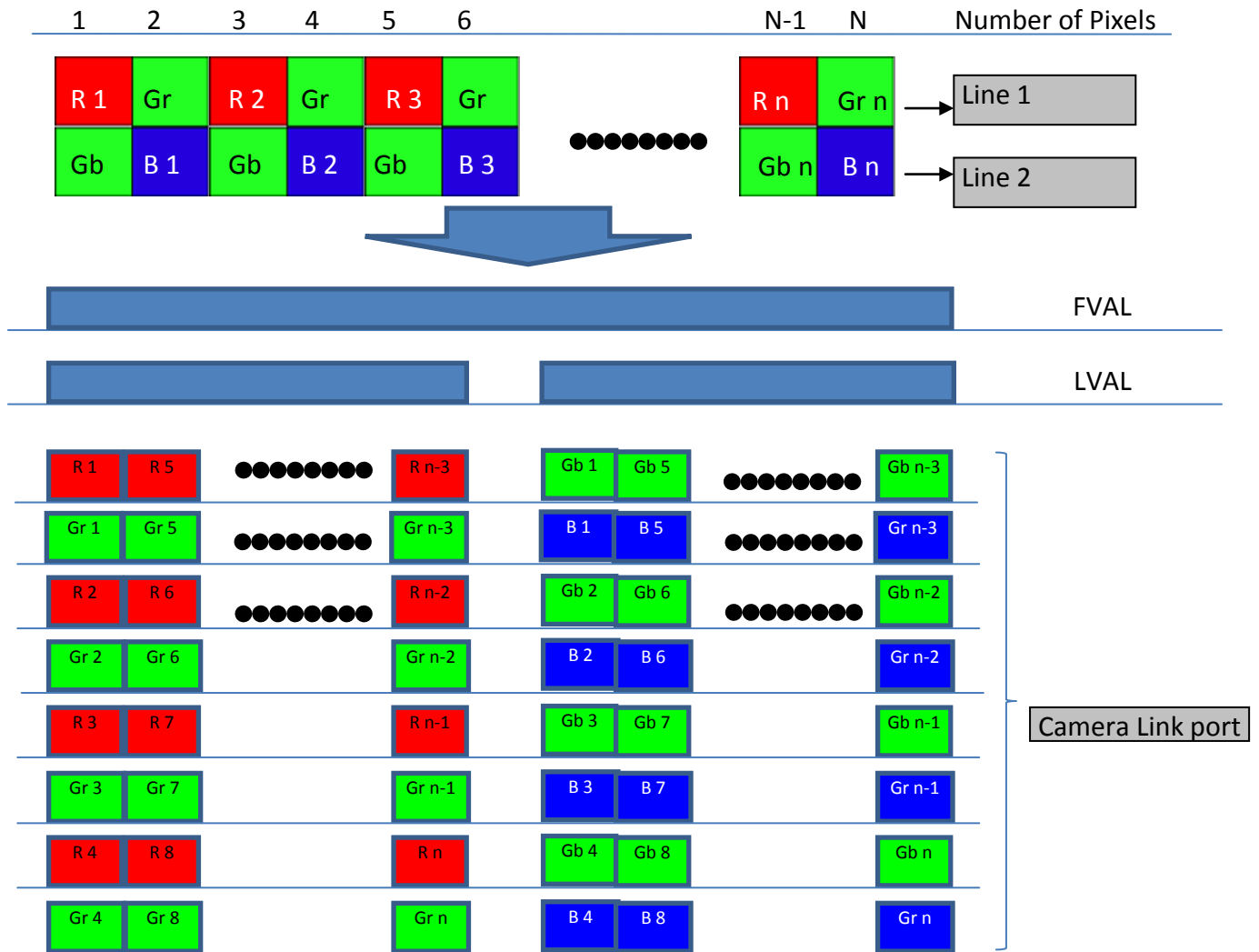

	FS-C4KU7DCL
N	4096
n	2048

R = Red Pixel
 Gr = green Pixel on Line1
 Gb = Green Pixel on Line2
 B = Blue Pixel

6. Video Output Formats

6.1 Video Output Format of FS-C2KU7DCL

- Selectable output modes are listed in the table below.
- Video output format can be selected through command opck.
- Another mode should not be used.
- Command opbt can change 8bit / 10bit.
- 10 bit output should be followed via Camera Link Specifications.

opck: Get Data Rate Mode

opbt: Output bit setting

opck	Output mode	Output pixels	Taps	Output bit (opbt)	Max line rate	Camera link clock	Sensor mode
11	RGB (Virtual Pixel1)	1024 x RGB	3	8bit or 10bit	80kHz	85MHz	9bit
8					75kHz	80MHz	
1					46kHz	50MHz	
13	RGB (Virtual Pixel2)	2048 x RGB	3	8bit or 10bit	40.5kHz	85MHz	
21					38.5kHz	80MHz	
14					24kHz	50MHz	
4	RAW2	2048x R,GR,GB,B	4	8bit or 10bit	80kHz	85MHz	9bit
10					75kHz	80MHz	
5					46kHz	50MHz	
35	RAW	2048x R/GR,GB/B	4	8bit or 10bit	80kHz	85MHz	9bit
36					75kHz	80MHz	
37					46kHz	50MHz	
39			2		75kHz	80MHz	
40					46kHz	50MHz	
27	AOI RGB (Virtual Pixel1)	1-1024 x RGB	3	8bit or 10bit	75kHz	80MHz	
28					46kHz	50MHz	
59	RGB (Virtual Pixel1)	1024 x RGB	3	8bit or 10bit	23.5kHz	25MHz	

Technical Terminology

Word	Description
(9bit)	9bit mode is that output 9bit data to increase the frame rate for reducing the output bit 10 to 9bit(Sensor still send 10 bit even in this mode). FFC value is saved for another FFC value for sensor's behavior is different from normal one.
Taps	It describes port number on 8bit camera link output. Number of cable is made effect for this Tap number(2,3 Tap(8bit): 1 cable,4 Tap(8bit): 2 cables).
Output pixels	This number describes the amount of data that output from camera.
Camera link clock	This number describes the clock speed of camera link output. Clock speed could make effect the selectable cable length. Shorter cable can sent faster clock.

6.1.1 8 bit x 3 tap RGB (Virtual Pixel 1)

Output mode(EHh)=11,8,1,59

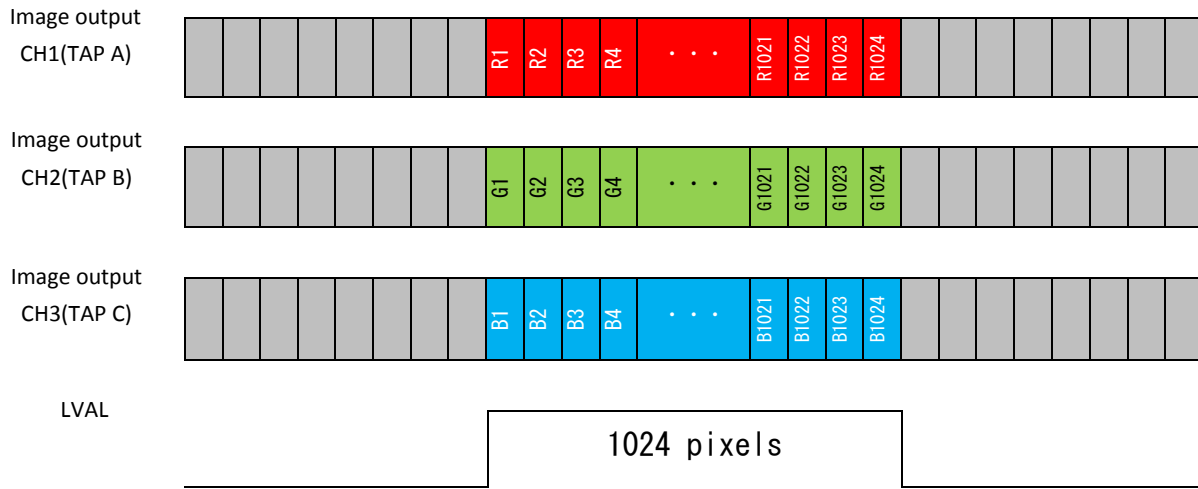

6.1.2 10 bit x 3 tap RGB (Virtual Pixel 1)

Output mode(EHh)=11,8,1,59

Follow as per Camera Link Specifications.

(This works on Medium Configuration)

6.1.3 8 bit x 3 tap RGB (Virtual Pixel 2)

Output mode(EHh)=13,21,14

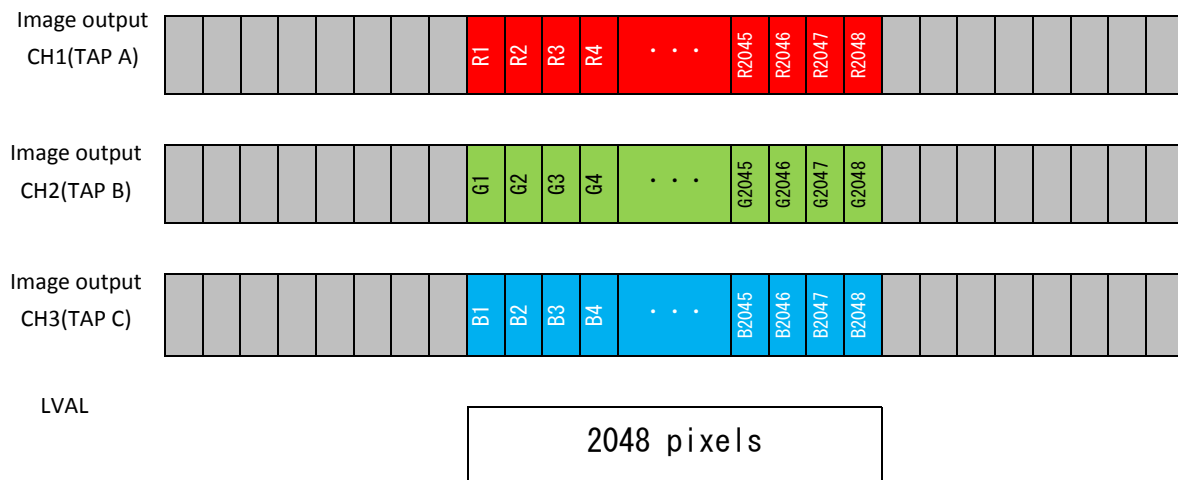

6.1.4 10 bit x 3 tap RGB (Virtual Pixel 2)

Output mode(EHh)=13,21,14

Follow as per Camera Link Specifications
(This works on Medium Configuration)

6.1.5 8 bit x 4 tap RAW Color

Output mode(EHh)=4,10,5

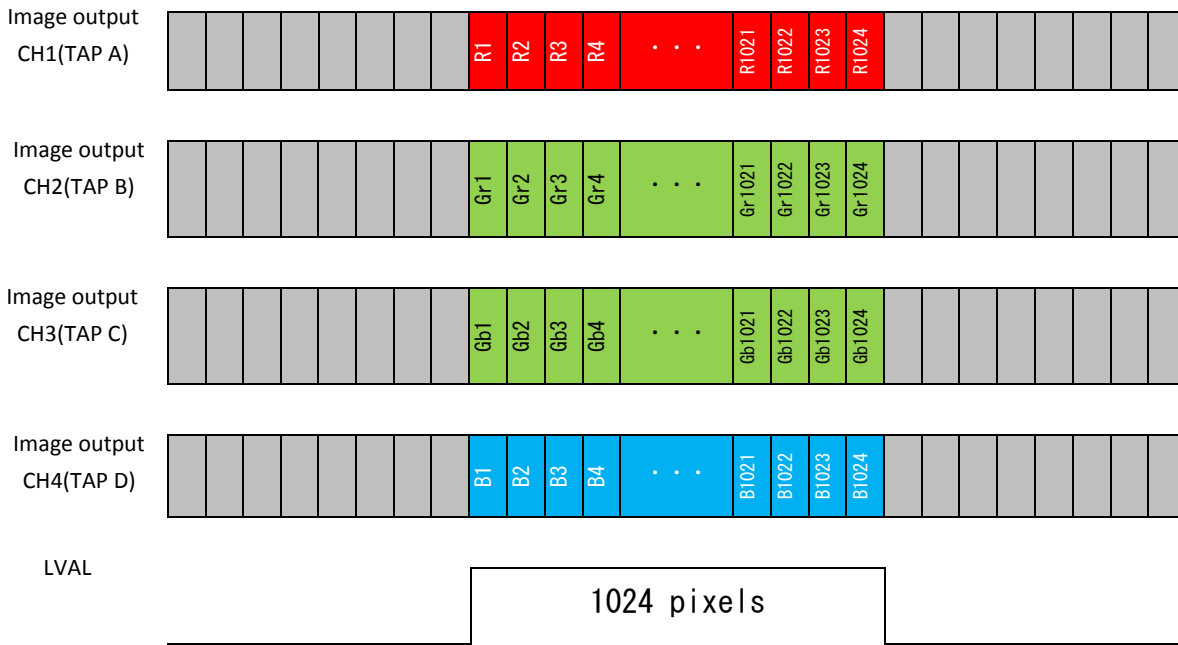

6.1.6 10 bit x 4 tap RAW Color

Output mode(EHh)=4,10,5

Follow as per Camera Link Specifications
(This works on Medium Configuration)

6.1.7 8 bit x 4 tap RAW Direct

Output mode(EEh)=35,36,37

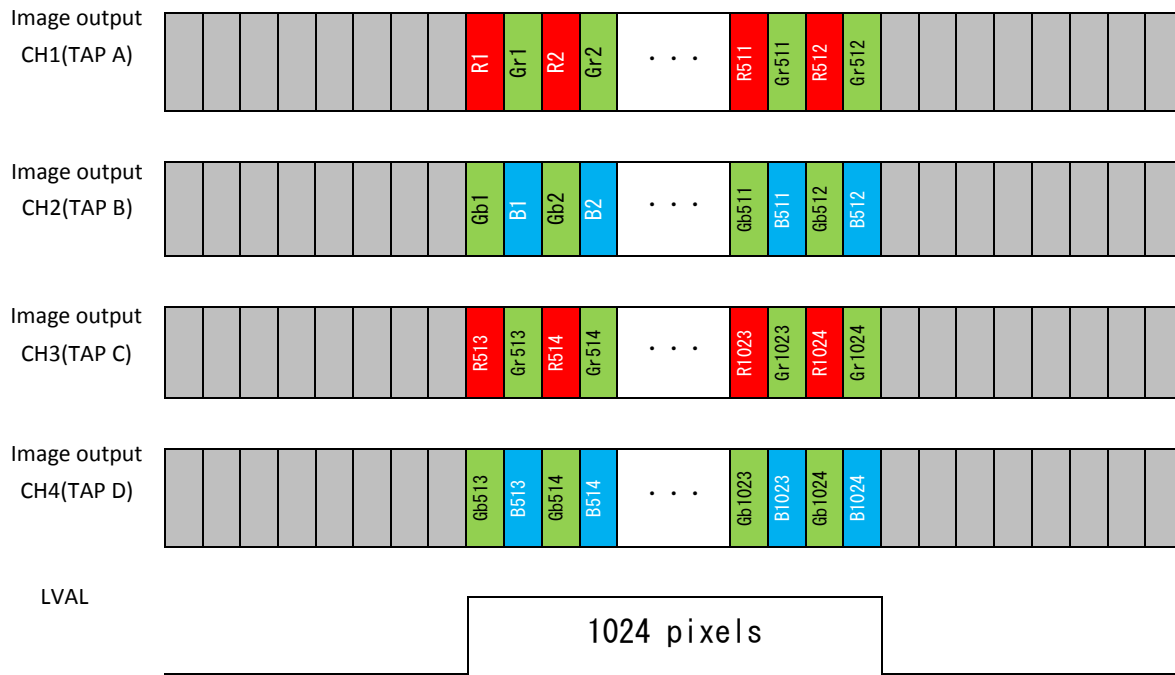

6.1.8 10 bit x 4 tap RAW Direct

Output mode(EEh)=35,36,37

Follow as per Camera Link Specifications.

6.1.9 8 bit x 8 tap RAW

Output mode(EEh)=39,40

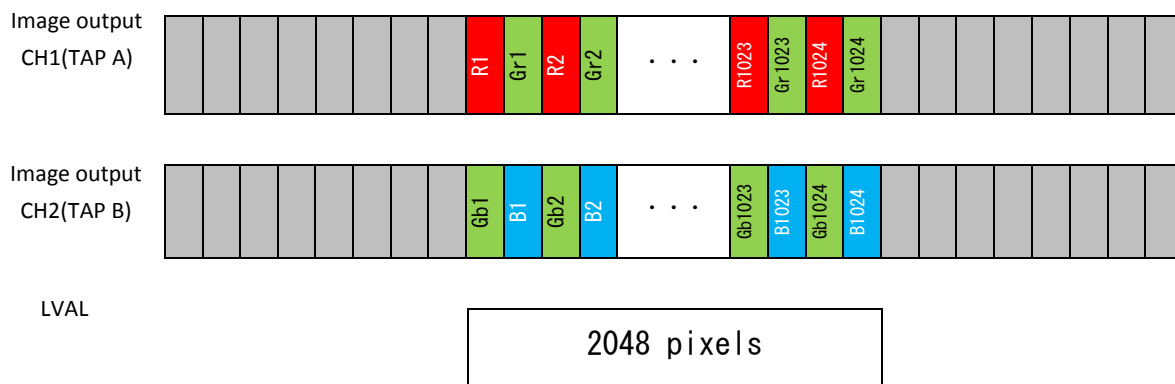

6.1.10 10 bit x 2 tap RAW Direct

Output mode(EH)=39,40

Follow as per Camera Link Specifications.

6.2. Video Output format of FS-C4KU7DCL

- Selectable output modes are listed in the table below.
- Video output format can be selected through command opck.
- Another mode should not be used.
- Command opbt can change 8bit / 10bit.
- 10 bit output should be followed via Camera Link Specifications.

opck: Get Data Rate Mode

opbt: Output bit setting

opck	Output mode	Output pixels	Taps	Output bit (opbt)	Max line rate	Camera link clock	Sensor mode
11	RGB (Virtual Pixel1)	2048 x RGB	6	8bit	80kHz	85MHz	9bit
8					75kHz	80MHz	
1					46kHz	50MHz	
2			3	8bit or 10bit	40.5kHz	85MHz	
9					38.5kHz	80MHz	
3					24kHz	50MHz	
13					RGB (Virtual Pixel2)	4096 x RGB	6
21	38.5kHz	80MHz					
14	24kHz	50MHz					
15	3	8bit or 10bit	20.5kHz	85MHz			
22			19kHz	80MHz			
16			12kHz	50MHz			
4	RAW Color	2048 x R,GR,GB,B	8	8bit	80kHz	85MHz	9bit
10					75kHz	80MHz	
5					46kHz	50MHz	
32			4	8bit or 10bit	40.5kHz	85MHz	
33					38.5kHz	80MHz	
34					24kHz	50MHz	
35	RAW Direct	2048 x R/GR,GB/B	8	8bit	80kHz	85MHz	9bit
36					75kHz	80MHz	
37					46kHz	50MHz	
38			4	8bit or 10bit	40.5kHz	85MHz	
39					38.5kHz	80MHz	
40					24kHz	50MHz	
41			2	8bit or 10bit	20.5kHz	85MHz	
42					19kHz	80MHz	
43					12kHz	50MHz	
27	AOI RGB (Virtual Pixel1)	1-2048 x RGB	3	8bit or 10bit	75kHz	80MHz	
28					46kHz	50MHz	
48	AOI RAW Direct	1-2048 x R/GR,GB/B	2	8bit or 10bit	75kHz	80MHz	
49					46kHz	50MHz	
51	AOI RAW Color	1-4096 x R,GR,GB,B	4	8bit or 10bit	75kHz	80MHz	
52					46kHz	50MHz	
24	AOI Raw Dual Line	1-512 x R/GR,GB/B	8	8bit	75kHz	80MHz	
25					46kHz	50MHz	
59	RGB (Virtual Pixel1)	2048 x RGB	6	8bit	23.5kHz	25MHz	

Technical Terminology

Word	Description
(9bit)	9bit mode is that output 9bit data to increase the frame rate for reducing the output bit 10 to 9bit(Sensor still send 10 bit even in this mode). FFC value is saved for another FFC value for sensor's behavior is different from normal one.
Taps	It describes port number on 8bit camera link output. Number of cable is made effect for this Tap number(2,3 Tap(8bit): 1 cable,4 Tap(8bit): 2 cables).
Output pixels	This number describes the amount of data that output from camera.
Camera link clock	This number describes the clock speed of camera link output. Clock speed could make effect the selectable cable length. Shorter cable can sent faster clock.

6.2.1 8 bit x 6 tap RGB (Virtual Pixel 1)

Output mode(EH)=11,8,1

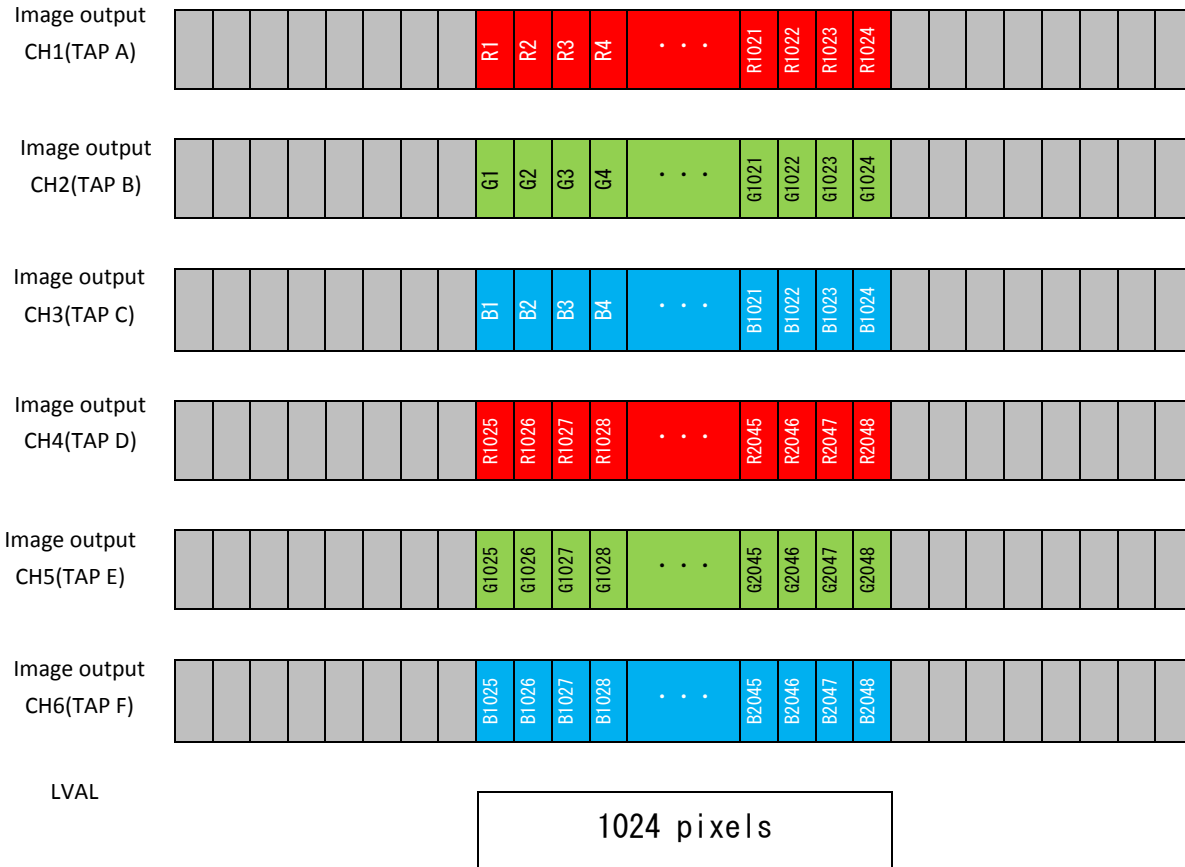

6.2.2 8 bit x 3 tap RGB (Virtual Pixel 1)

Output mode(EHh)=2,9,3

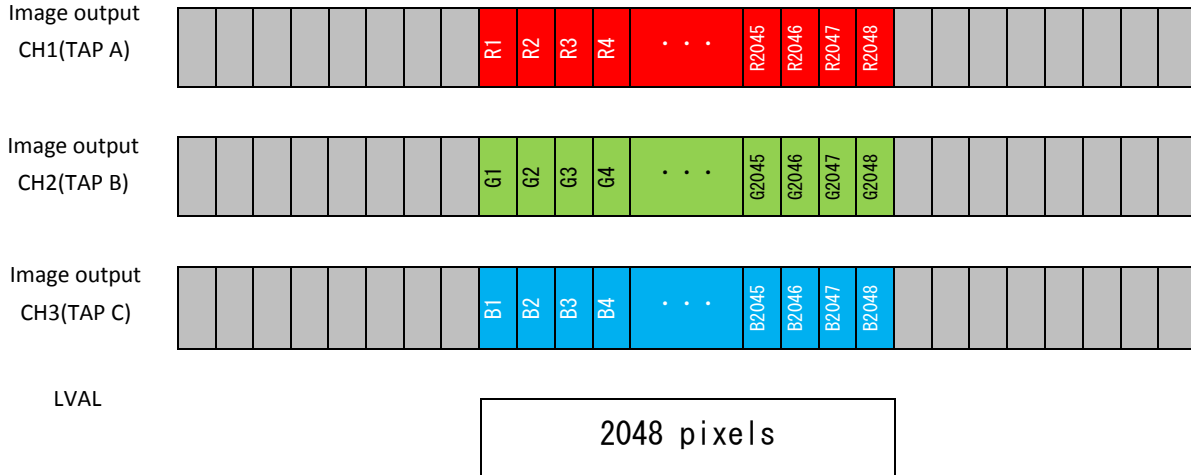

6.2.3 10 bit x 3 tap RGB (Virtual Pixel 1)

Output mode(EHh)=2,9,3

Follow as per Camera Link Specifications.
(This works on Medium Configuration)

6.2.4 8 bit x 6 tap RGB (Virtual Pixel 2)

Output mode(EH)=13,21,14

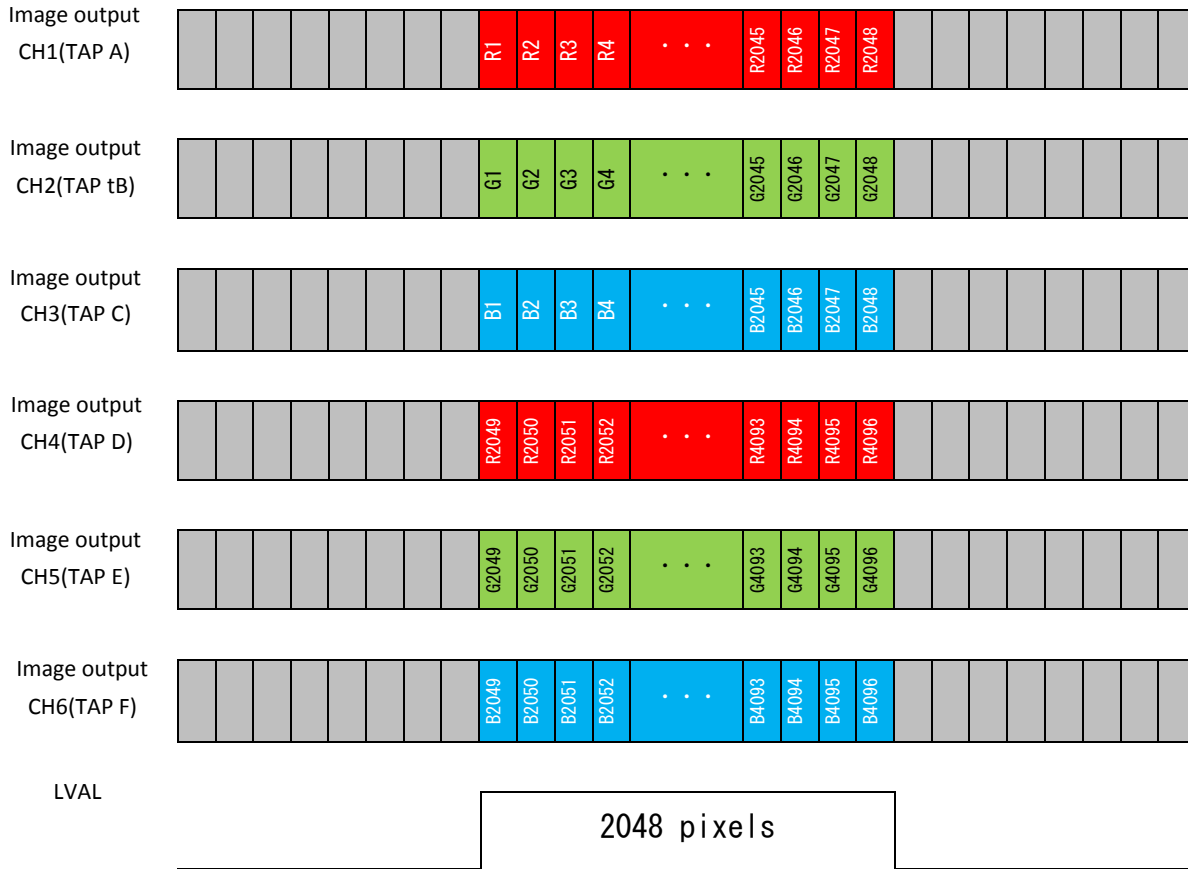

6.2.5 8 bit x 3 tap RGB (Virtual Pixel 2)

Output mode(EH)=15,22,16

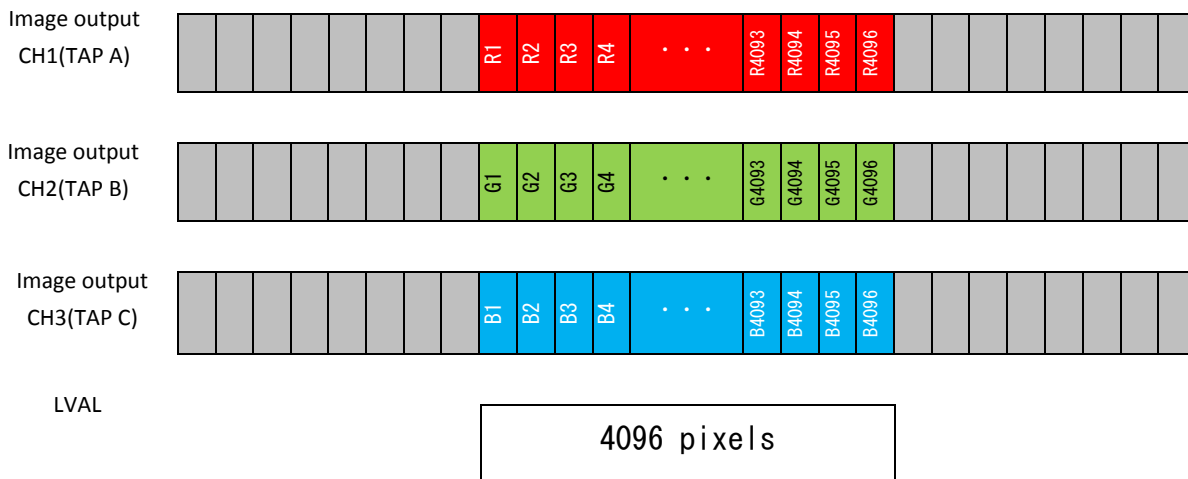

6.2.6 10 bit x 3 tap RGB (Virtual Pixel 2)

Output mode(EEh)=15,22,16

Follow as per Camera Link Specifications

(This works on Medium Configuration)

6.2.7 8 bit x 8 tap RAW Color

Output mode(EEh)=4,10,5

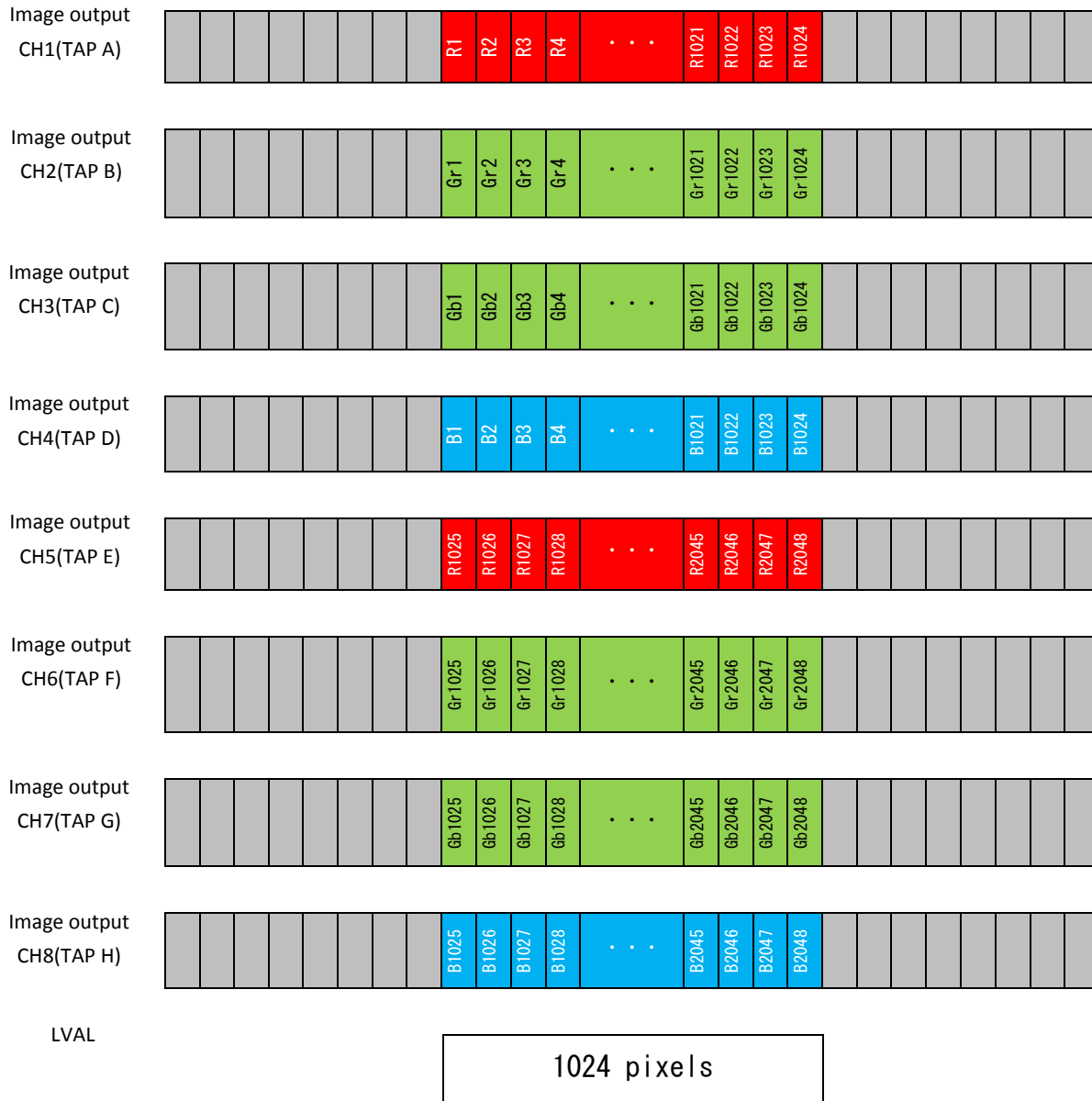

6.2.8 10 bit x 8 tap RAW Color

Output mode(EH)=4,10,5

Follow as per Camera Link Specifications.

6.2.9 8 bit x 4 tap RAW Color

Output mode(EH)=32,33,34

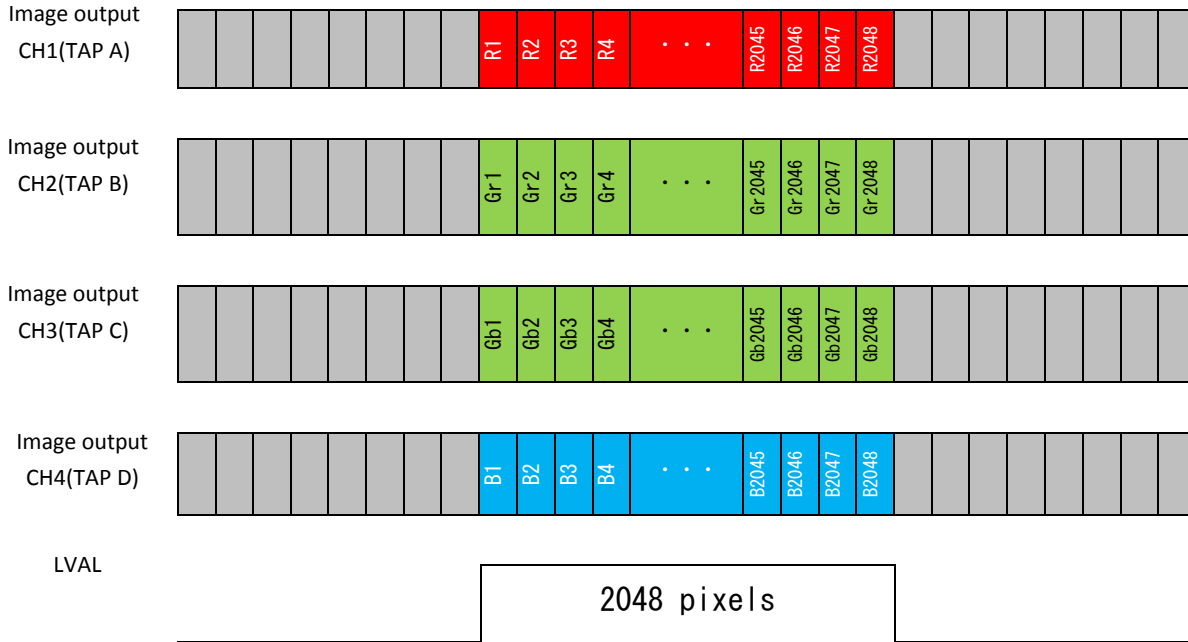

6.2.10 10 bit x 4 tap RAW Color

Output mode(EH)=32,33,34

Follow as per Camera Link Specifications.

6.2.11 8 bit x 8 tap RAW Direct

Output mode(EH)=35,36,37

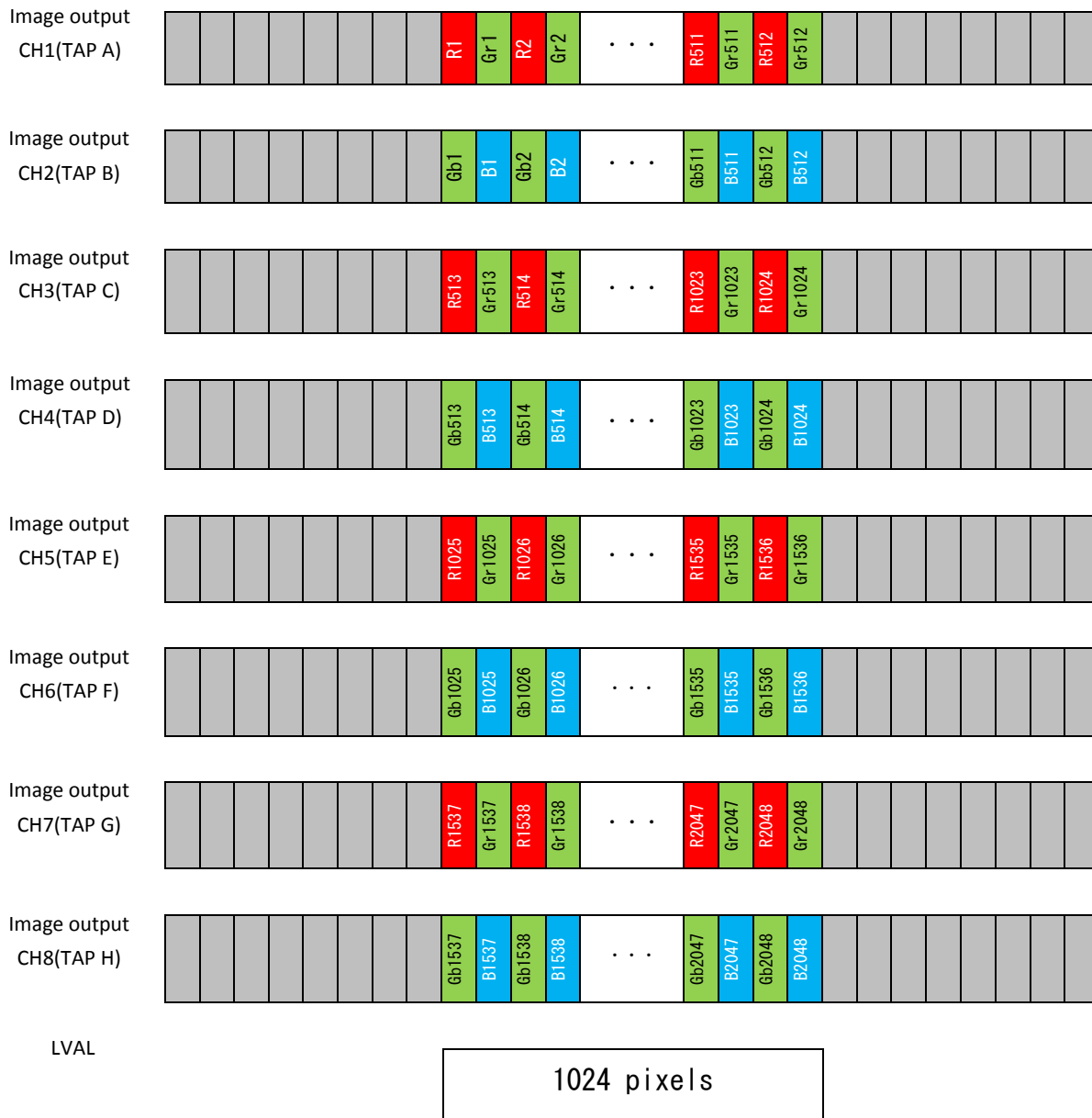

6.2.12 8 bit x 4 tap RAW Direct

Output mode(EEh)=38,39,40

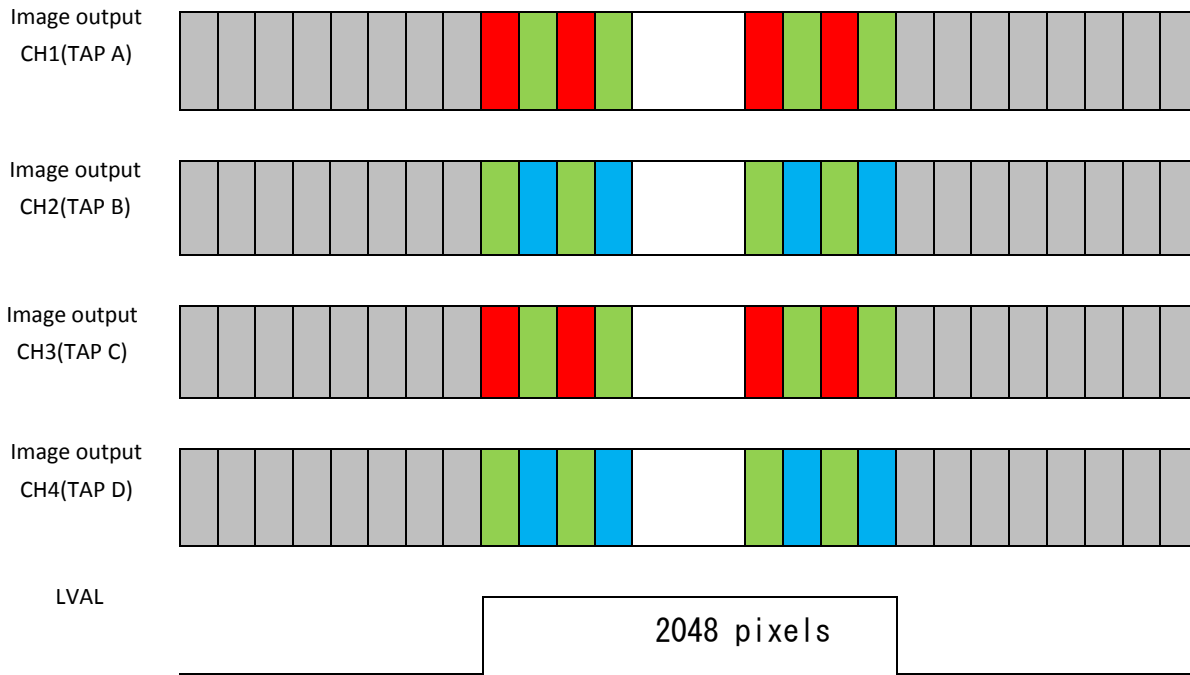

6.2.13 10 bit x 4 tap RAW Direct

Output mode(EEh)=38,39,40

Follow as per the Camera Link Specifications.

6.2.14 8 bit x 2 tap RAW Direct

Output mode(EEh)=41,42,43

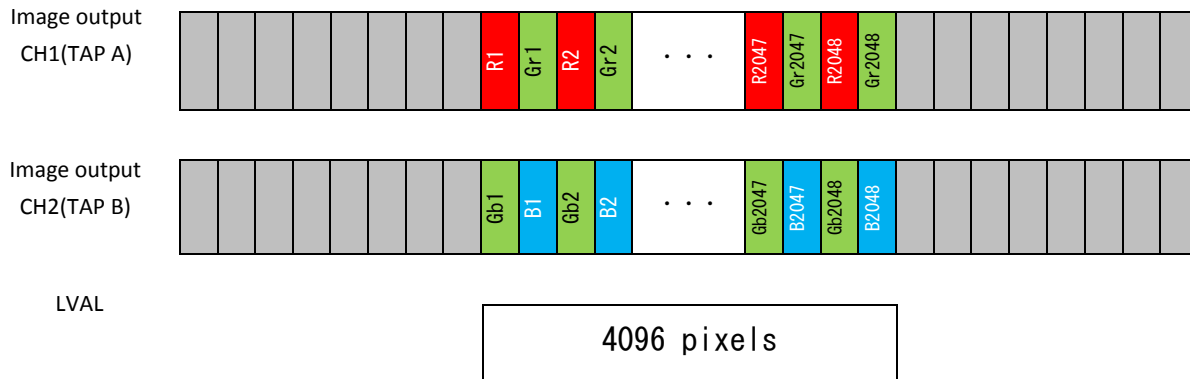

6.2.15 10 bit x 2 tap RAW Direct

Output mode(EH)=41,42,43

Follow as per Camera Link Specifications.

6.2.16 8 bit x 8 tap Raw Dual Line

Output mode(EH)=24,25

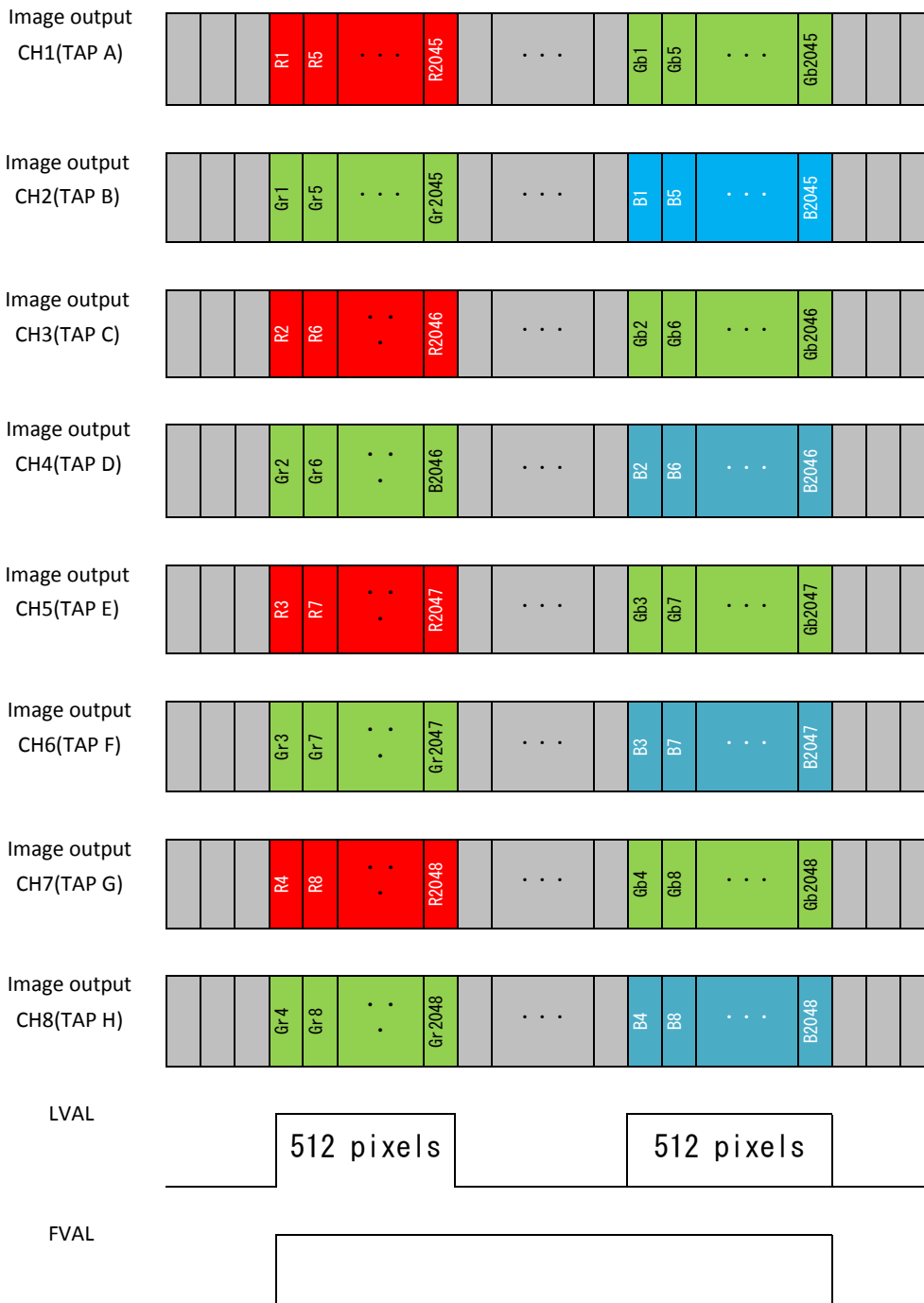

6.3. Video Output Format of FS-C8KU7DCL

- Selectable output modes are listed in the table below.
- Video output format can be selected through the command opck.
- Any other modes should not be used.
- Command opbt can change 8 bit / 10 bit.
- 10 bit output should be used as per Camera Link Specifications.

opck: Get data rate mode

opbt : Output bit setting

opck	Output mode	Output pixels	Taps	Output bit	MaxLinerate	CameralinkClock	SensorMode
11	RGB (Virtual Pixel1)	4096 x RGB	6	8bit	40kHz	85MHz	9bit
8					38.5kHz	80MHz	
1					24kHz	50MHz	
2			3	8bit or 10bit	20.5kHz	85MHz	
9					19kHz	80MHz	
3					12kHz	50MHz	
13	RGB (Virtual Pixel2)	8192 x RGB	6	8bit	20.5kHz	85MHz	
21					19kHz	80MHz	
14					12kHz	50MHz	
15			3	8bit or 10bit	10kHz	85MHz	
22					9.5kHz	80MHz	
16					6kHz	50MHz	
4	RAW Color	4096 x R,GR,GB,B	8	8bit	40kHz	85MHz	9bit
10					38.5kHz	80MHz	
5					24kHz	50MHz	
32			4	8bit or 10bit	20.5kHz	85MHz	
33					19kHz	80MHz	
34					12kHz	50MHz	
35	RAW Direct	4096 x R/GR,GB/B	8	8bit	40kHz	85MHz	9bit
36					38.5kHz	80MHz	
37					24kHz	50MHz	
38			4	8bit or 10bit	20.5kHz	85MHz	
39					19kHz	80MHz	
40					12kHz	50MHz	
41			2	8bit or 10bit	10kHz	85MHz	
42					9.5kHz	80MHz	
43					6kHz	50MHz	
27	AOI RGB (Virtual Pixel1)	1-4096 x RGB	3	8bit or 10bit	38.5kHz	80MHz	
28					24kHz	50MHz	
48	AOI RAW Direct	1-4096 x R/GR,GB/B	2	8bit or 10bit	38.5kHz	80MHz	
49					24kHz	50MHz	
51	AOI RAW Color	1-4096 x R,GR,GB,B	4	8bit or 10bit	38.5kHz	80MHz	
52					24kHz	50MHz	
24	Raw Dual Line	1-4096 x R/GR,GB/B	8	8bit	38.5kHz	80MHz	
25					24kHz	50MHz	
59	RGB	4096 x RGB	6	8bit	12kHz	25MHz	

6.3.1 8 bit x 6 tap RGB (Virtual Pixel 1)

Output mode(EH)=11,8,1

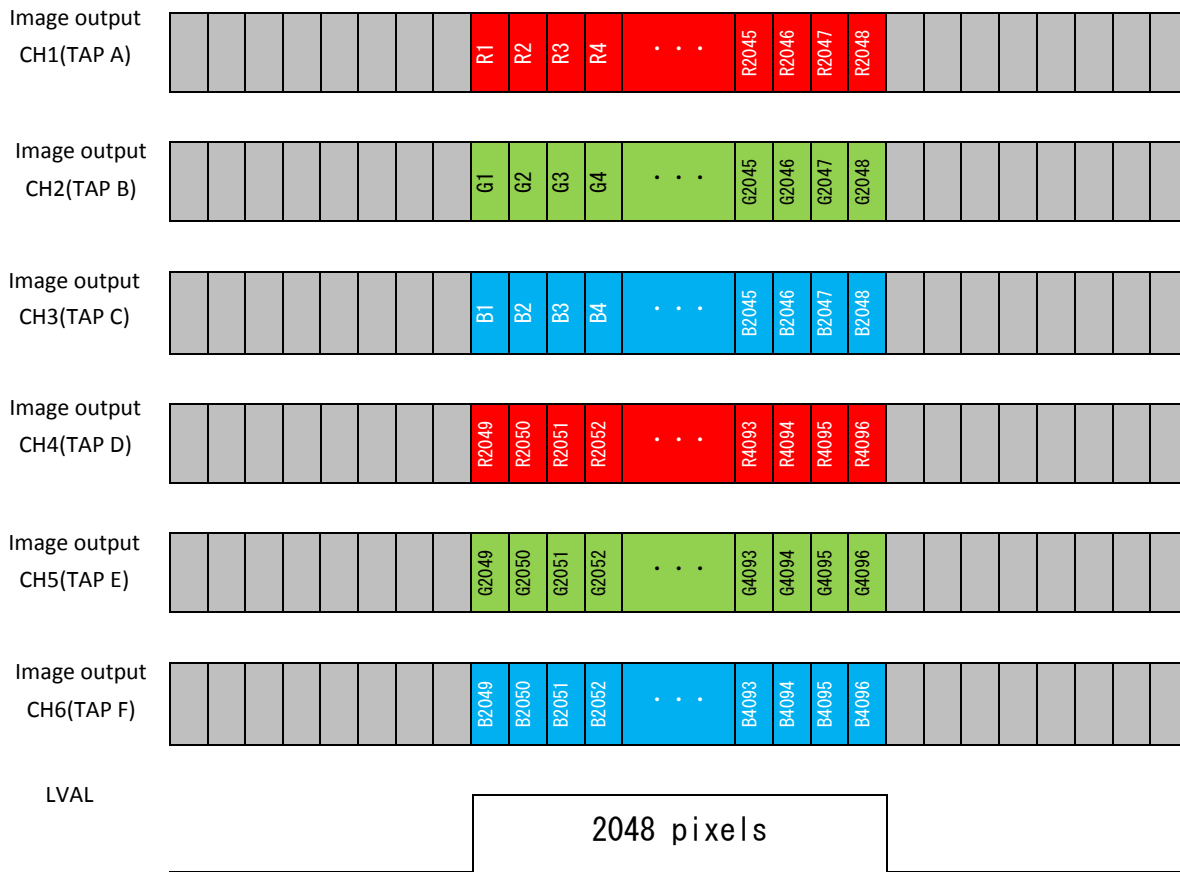

6.3.2 8 bit x 3 tap RGB (Virtual Pixel 1)

Output mode(EH)=2,9,3

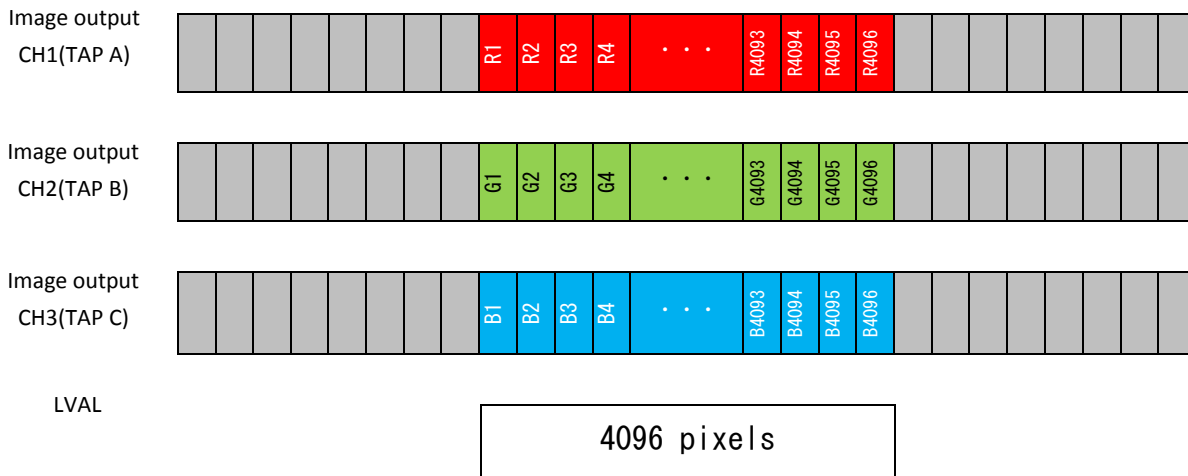

6.3.3 10 bit x 3 tap RGB (Virtual Pixel 1)

Output mode(EH)=2,9,3

Follow as per Camera Link Specifications.

6.3.4 8 bit x 6 tap RGB (Virtual Pixel 2)

Output mode(EH)13,21,14

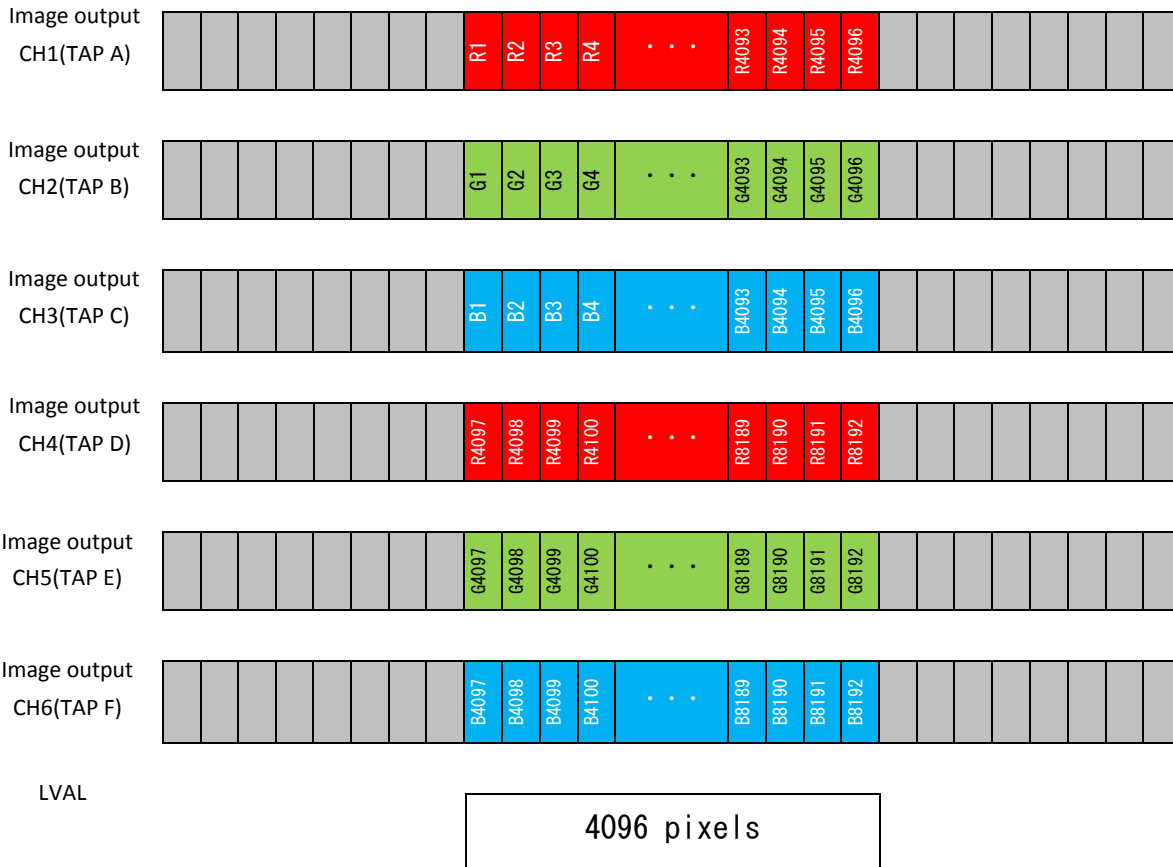

6.3.5 8 bit x 3 tap RGB (Virtual Pixel 2)

Output mode(EH)=15,22,14

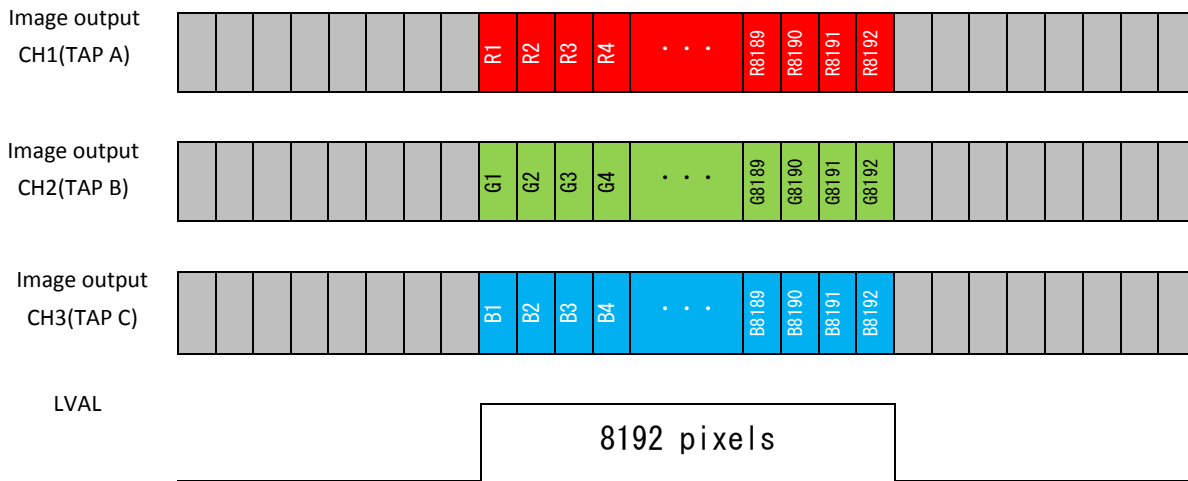

6.3.6 10 bit x 3 tap RGB (Virtual Pixel 2)

Output mode(EEH)=15,22,14

Follow as per Camera Link Specifications

(This works on Medium configuration)

6.3.7 8 bit x 8 tap RAW COLOR

Output mode(EH)=4,10,5

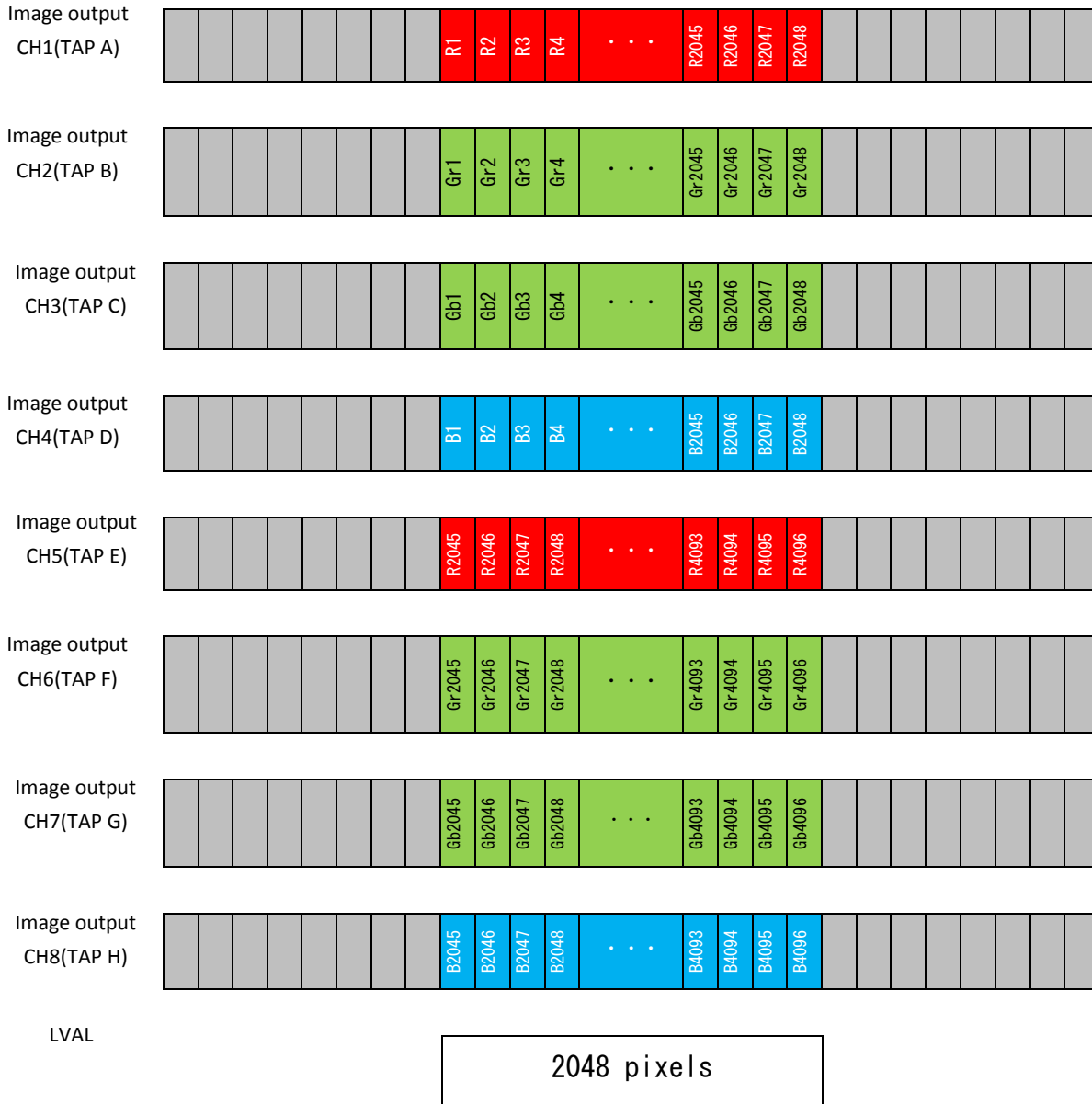

6.3.8 10 bit x 8 tap RAW COLOR

Output mode(EHh)=4,10,5
Follow as per Camera Link specifications.

6.3.9 8 bit x 4 tap RAW COLOR

Output mode(EHh)=32,33,34

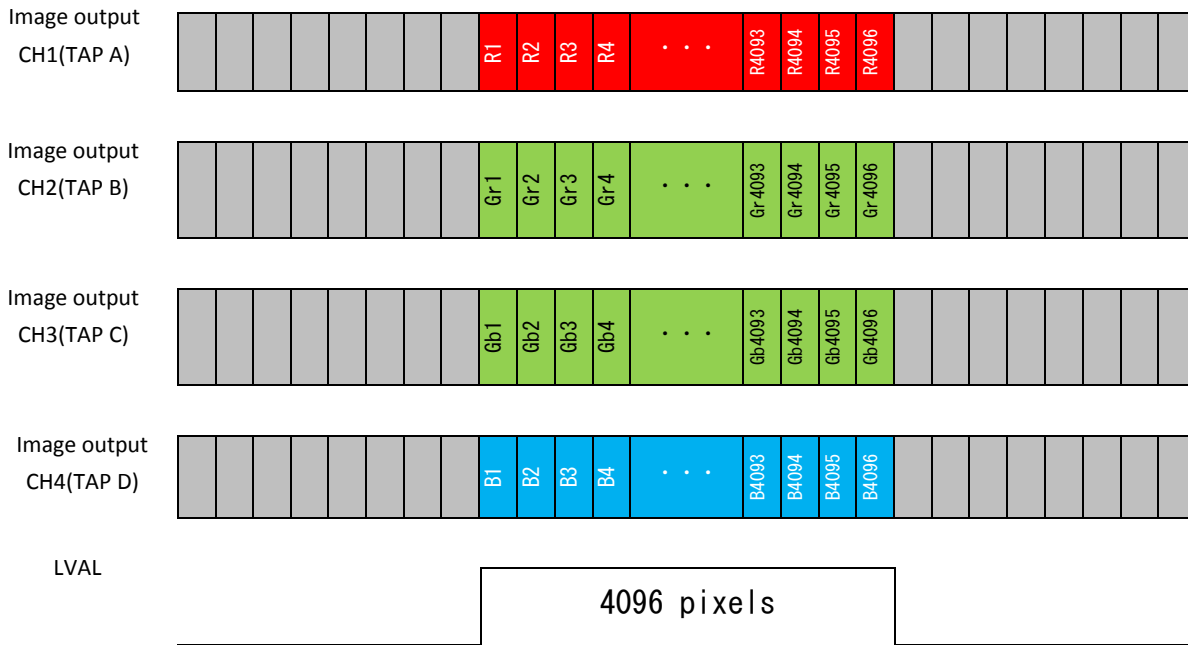

6.3.10 10 bit x 4 tap RAW COLOR

Output mode(EHh)=32,33,34
Follow as per Camera Link specifications.

6.3.11 8 bit x 8 tap RAW Direct

Output mode(EH)=35,36,37

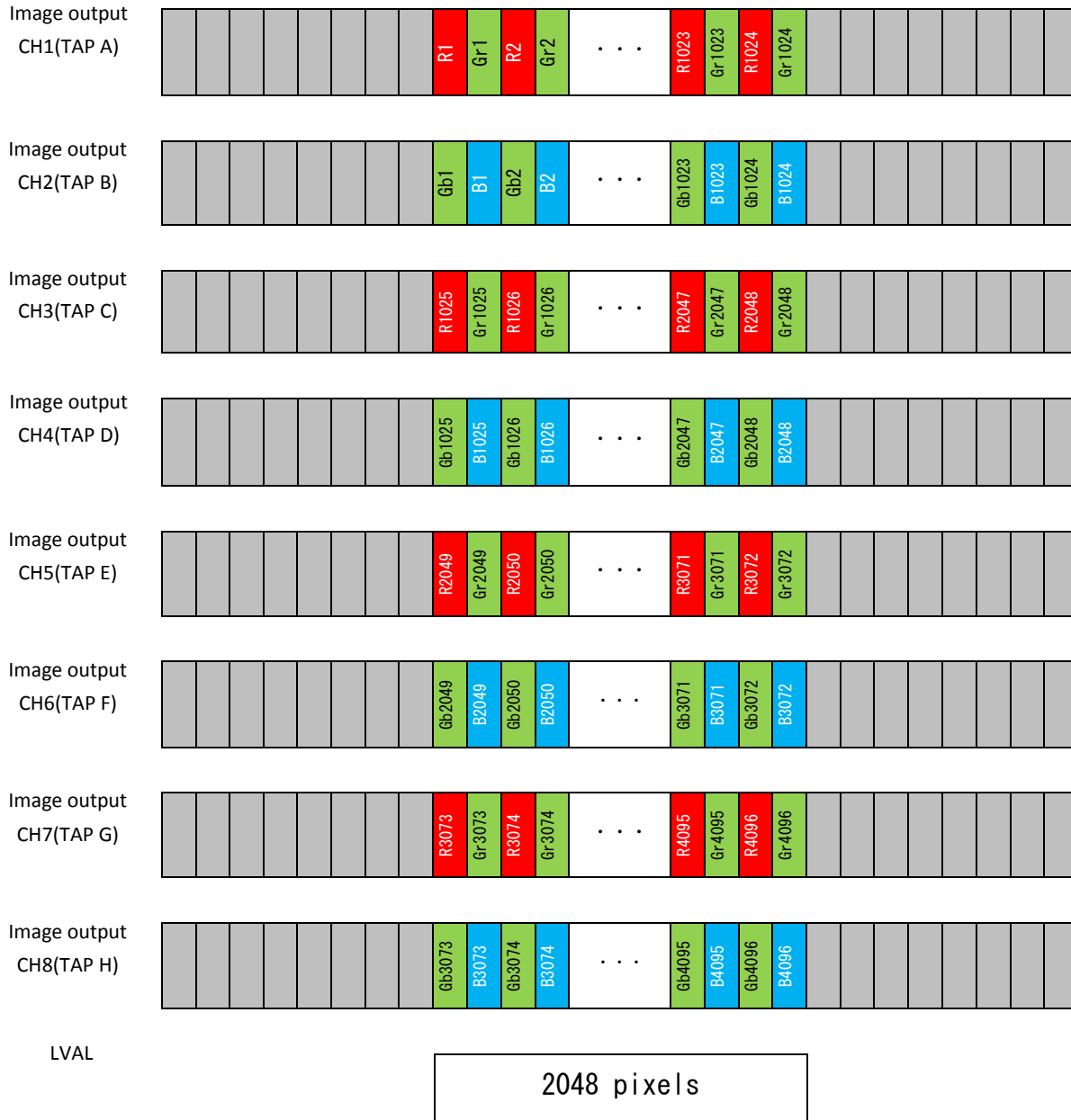

6.3.12 8 bit x 4 tap RAW Direct

Output mode(EHh)=38,39,40

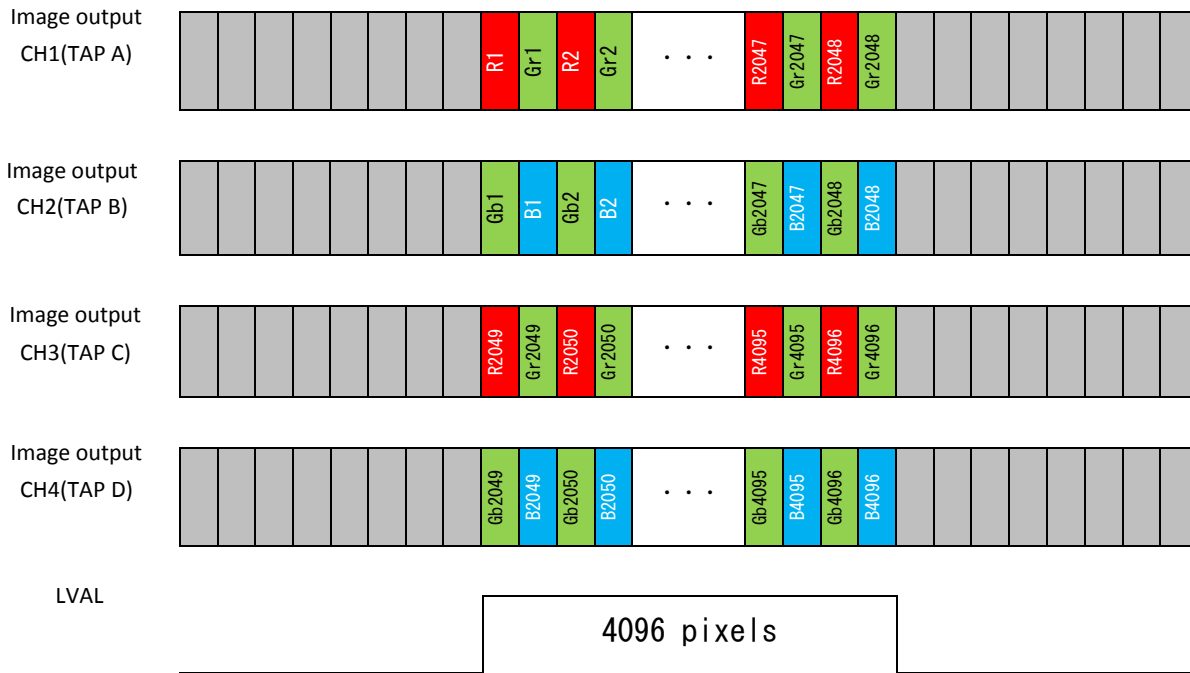

6.3.13 10 bit x 4 tap RAW Direct

Output mode(EHh)=38,39,40

Follow as per Camera Link Specifications.

6.3.14 8 bit x 2 tap RAW Direct

Output mode(EHh)=41,42,43

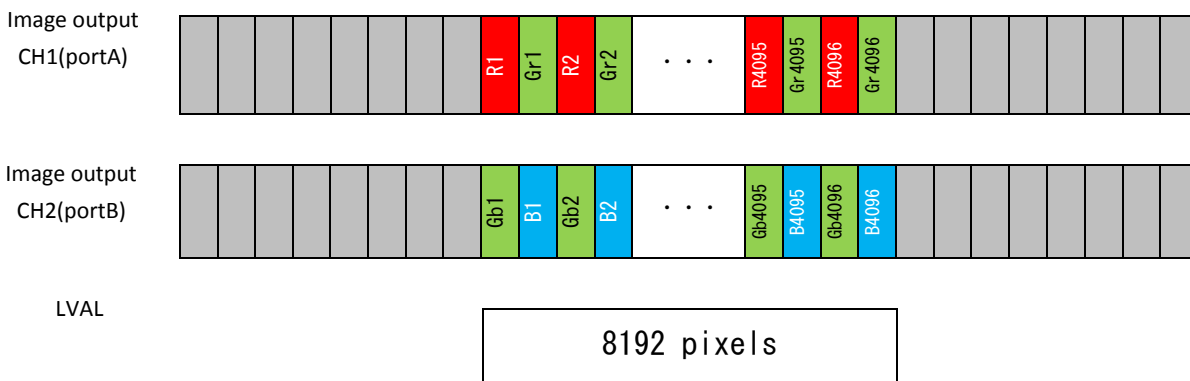

6.3.15 10 bit x 2 tap RAW Direct

Output mode(EH)=41,42,43

Follow as per Camera Link specifications.

6.3.16 8 bit x 8 tap RAW Dual Line

Output mode(EH)=24,25

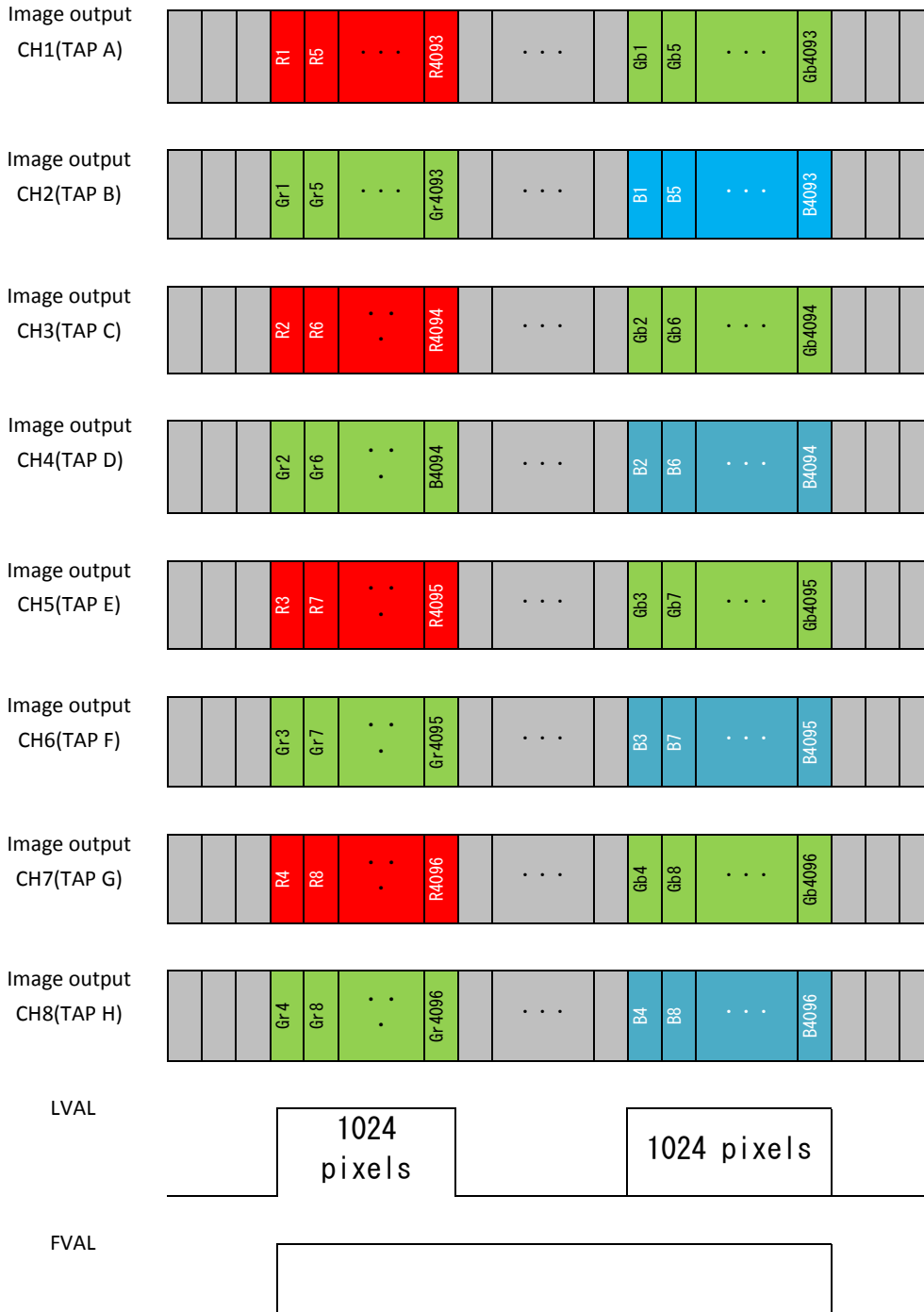

7. Details of Camera Control

7.1 Field Flat Correction (FFC)

Field Flat Correction (FFC) is used for correcting non-uniformity image brightness caused by the lens of the imager. When using this camera, FFC should be used to help correct fixed pattern noise on the imager.

7.1.1 Summary of FFC

When using FFC, the gain and offset are added to each pixel. Adding the gain helps to flatten the gray video level and adding the offset helps to flatten the Shield Light Level. The concept FFC is shown on the chart below.

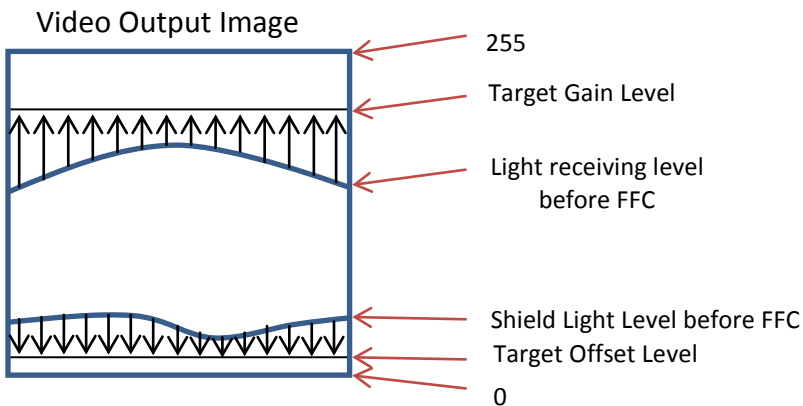

Gain and offset value for each pixel can set through the Auto Mode and Manual mode.

7.1.2 Technical Terminology

[AAh: B]

Please set the value on the address as below through the communication protocol.

AA: Register address (Hex)

B: Value (Dec)

7.1.3 Auto FFC Procedure

After the target gain and offset levels have been set, the camera will correct the gain and offset value automatically under the calibration setting.

The user has to set the FFC under their personal conditions. If the wrong procedure is executed, the correction can be recovered from the beginning.

[Procedure]

- 1) Set the OFF on [FFC Mode] [81h: 0]
(This register is the trigger at 4)
- 2) Set the value on [Target FFC Offset] [8Ah: 5]
(Set the offset value (range: 0 to 255, recommended: 5))
- 3) Shield the light.
- 4) Set the Auto(offset) on [FFC Mode] [81h: 6]

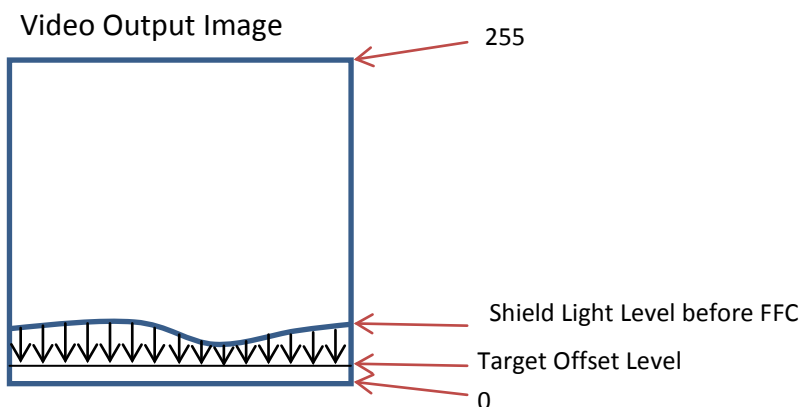

- 5) Set the ON (only Offset) on [FFC Mode] [81h: 7]
(This setting is necessary to determine the target level for checking the actual video image at the next step.)
- 6) Un-Cover the sensor
Please do not saturate the image.
Focus the camera on a smooth white clean object for calibration and set the parameters to the actual condition.

Note:

If the case is "Auto Target" → jump to step 11

Auto Target is the function that sets the target gain level automatically.

The formula Target gain level = Maximum light receiving level + α is used to determine the target gain level.

If the case is "Fixed Target Level" → continue to step 7

7) Set [Target FFC Gain] level [88h: 200]

Configurable range is 0 to 255.

The value should be ten steps larger than the brightest level on the video image.

A brighter video value than the target gain level outputs the data without correction.

Initial [Target FFC Gain] level is 200. User can adjust this level with actual video image.

8) Set the Auto (Gain) on [FFC Mode] [81h: 5]

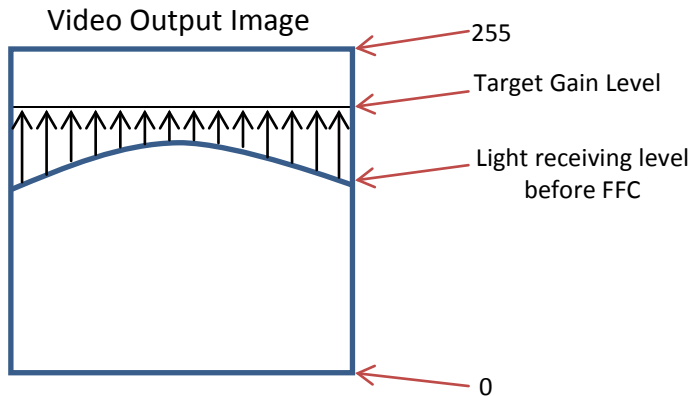

9) Confirm the FFC Function

Set the ON (Gain + Offset) on [FFC Mode] [81h: 1]

10) Check the Saturation Level

The Saturation Level should be set to 255.

Please extend the exposure time, increase the light, or open the IRIS.

If un-saturated (less than 255) exist, please set the [Target FFC Gain] [88h:] again. This value should be larger than the previous value.

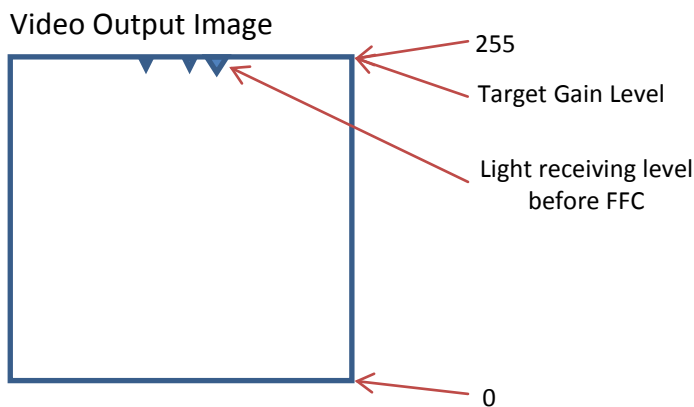

If the user is utilizing FFC Setting (Auto) this is the end of the process.

If the user is using “Auto Target”, please continue in the following steps.

11) Set the Target Offset level for gain [88h: recommendation 20]

Set the value from the range 0 to 255 (8bit)

To determine the target level automatically, offset level has to be set.

(Target level should be the same value of this Target offset level plus highest point of light receiving level)

12) Set the Auto of FFC Mode (Gain) (Auto Offset) [81h: 8]

Gain correction works automatically.

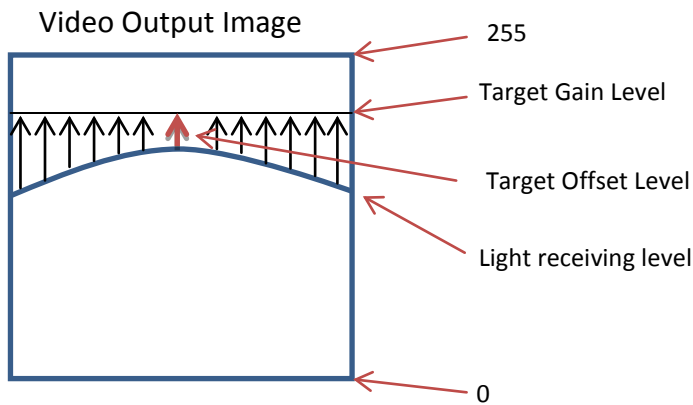

7.1.4 Manual FFC Procedure

The Manual [FFC Mode] can correct specific pixel addresses and correct all pixels of the same value.

When dust creates a gap in the calibration object after Auto on [FFC Mode], the user can revise the value of the specific pixel address.

[Procedure (by Pixel)]

- 1) Set the Manual (all pixels) on [FFC Mode] [81h: 3]
- 2) Set the Select FFC (Gain, Offset) to determine the output gain or offset [82h: 1 or 2]
- 3) Set the pixel address on [FFC Address] [86-87h:]
- 4) Set the FFC Value on [FFC Data] [84-85h:]
- 5) Set the "1" on [Set FFC] to reflect the setting on the camera [E1h: 4: 1]

[Procedure (all Pixels)]

- 1) Set the Manual (all pixels) on [FFC Mode] [81h: 4]
- 2) Set the Select FFC (Gain, Offset) to determine the output gain or offset [82h: 1 or 2]
- 3) Set the FFC value on [FFC Data] [84-85h]
- 4) Set the "1" on [Set FFC] to reflect the setting on the camera [E1h.4: 1]

7.1.5 Confirm FFC

FFC value (Gain / Offset) can be confirmed for each pixel as the video output data.

[Procedure]

- 1) Set the FFC value on [FFC Mode] [81h: 2]
- 2) Set the Select FFC (Gain, Offset) to determine the output gain or offset [82h: 1 or 2]
- 3) Set the [FFC Corrected Value Output] to determine the outputs lower or upper byte [83h:]

7.1.6 Save FFC

[FFC Data] can be saved on the EEPROM / FLASH memory. Once the data has been saved to the EEPROM / FLASH memory, FFC values will remain after turning off the camera.

Save FFC [E1h.6: 1]

Load FFC [E1h.7: 1]

7.1.7 FFC Corrected Value Store Mode

FFC is required to erase the fixed pattern noise from the image sensor. Twelve FFC corrected value can be stored.

		8Ch	EEh	8Dh	Load Camera Setting	Save Camera Setting	Camera turn on
Area0	Factory Setting Area	-	11	-	E2h.3	Disable	Data may not be loaded
Area1		-	excpet11	-			
Area2	User Default Access Area	0	11	-	E2h.1	E2h.0	Saved data on the EEPROM will be loaded automatically.
Area3		0	excpet11	-			
Area4	UserBANK Area(bank0)	1	-	0			
...			
Area11	UserBANK Area(bank7)	1	-	7			

Factory Setting Area:

FFC corrected values on the factory setting are stored in this area. (Factory Setting: No lens, with Lens Mount, Flat Light source)

The user cannot save data into this area.

Use Default Access Area:

The user can use this area to save and load the FFC corrected values on 8CH=0.

UserBANK Area:

The user can store corrected FFC data in this area. This area can be used to store settings under several different environments (e.g. different shutter, lighting, etc.)

When this area is used, please set the 8Ch=1 and select the UserBANK Area on 8Dh=0-7(Eight banks exist)

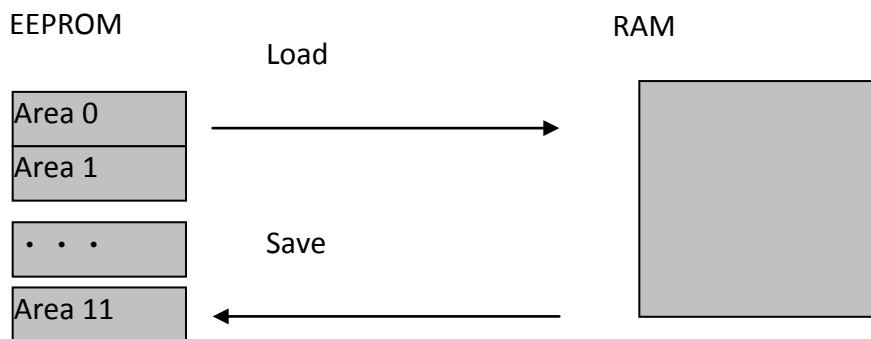

[Note]

*Only one RAM exists.

* When in use, the camera refers to the FFC corrected value on the RAM, EEPROM is used for storage.

*The reason Factory Setting Area and User Default Access Area have two areas:

The sensors characteristics are different on EEh=11 and another. FFC corrected values exist for each mode. FFC corrected values may be automatically loaded EEh is changed from EEh=11 to another or another to EEh=11 under 8Ch=0. If 8Ch=1 is used, the FFC corrected data will not be loaded automatically. The user has to control which setting (on EEh) should be stored on each bank.

8. The Communication Protocol Specifications

This camera has the communication function that enables external devices (such as a PC) control the camera functions. Please use “CLCtrl” communication software or use the following communication protocol to communicate to the camera.

8.1 The Communication Method

UART(RS232C), binary communication.

8.2 The Communication Settings

	Settings
Baud rate	9,600bps / 38,400bps
Data bit	8bit
Parity	None
Stop bit	1bit
Flow control	None

8.3 The Communication Format

A. The format for sending data from the PC to the camera is as follows:

a. Send the Read command

SOF (8bit)	Device code (6bit)	Read (1bit)	Page selection (1bit)	Command code (8bit)	Data length (8bit)	Data (1byte)	EOF (8bit)
---------------	-----------------------	----------------	--------------------------	------------------------	-----------------------	-----------------	---------------

b. Send the Write Command

SOF (8bit)	Device code (6bit)	Write (1bit)	Page selection (1bit)	Command code (8bit)	Data length (8bit)	Data (Data length byte)	EOF (8bit)
---------------	-----------------------	-----------------	--------------------------	------------------------	-----------------------	----------------------------	---------------

B. The format for receiving data from the camera is as follows:

a. After the Read command has been sent

SOF (8bit)	Data length (8bit)	Data (Data length byte)	EOF (8bit)
---------------	-----------------------	----------------------------	---------------

b. After the Write command has been sent

SOF (8bit)	Data length (8bit) "00"	Receiving code (8bit)	EOF (8bit)
---------------	----------------------------	--------------------------	---------------

C. Descriptions of the Format

Name	Descriptions
SOF	Start of the frame Sets (or gets) the value is "02H" always.
Device code	Sets the device code of the camera is "000000".
Read / Write	Sets (or gets) "0" when the read command is sent. Sets (or gets) "1" when the write command is sent.
Page selection	Sets "0" when accessing the command register of the camera Gets current data from the command register when sent read command. The data of the command register is replaced by the sent data when sent write command. The data of the EEPROM is not replaced. Sets "1" when accessing the EEPROM of the camera The camera works with the data of the EEPROM when the camera is powered on. Gets the data from the EEPROM when sent read. The data of the EEPROM is replaced by sent data when sent write command. The camera sends the receiving code as "01H" to the PC after the data of the EEPROM is replaced. The camera rejects other commands while the data of the EEPROM is being replaced (approximately 5 msec. / byte).
Command code	Please refer from the following page.
Data length	Data length (Unit: byte) Receiving data The data length is dependent on the command after the read command is sent. The data length is "00H" after the write command is sent. Sending data The data length is 1 byte when the read command is sent. The data length is dependent on the command when the write command is sent.
Data	The value of the data is dependent on the command
EOF	End of the frame Sets (or gets) the value is "03H" always
Receiving code	Result of the sent command.

D. Example Commands

Send the Read command to Read the 00H address data of the register

02, 00, 00, 01, 00, 03

SOF, (Device code / Read / Register), Command Code, Data Length, Data, EOF

The Return Command:

02, 01, 00, 03

8.4 The Camera Control Commands

8.4.1 The Camera Command List

Note1: The data unit of each command is 1 byte (8bit).

Note2: The data can be saved to the EEPROM if “x” is in the “Save to EEPROM” column in the list.

Note3: The camera is operating with the data of the EEPROM when the camera is powered on.

Device Code	Command Number	Start bit	bit number	Read/Write	FLASH Write	Description	Initial Data	Range
000000	10h	0	2	R/W	○	Exposure Mode	0	0 ~ 3
	11h	0	2	R/W	○	Sync Mode	2	0 ~ 3
	12h	0	1	R/W	○	Video Out	0	0 ~ 1
	20h	0	16	R/W	○	Exposure Time	0	0 ~ 65535
	31h	0	8	R/W	○	Digital Gain	0	0 ~ 255
	34h	0	1	R/W	○	Analog Gain	0	0 ~ 1
	78h	0	4	R/W	○	Test Pattern	0	0 ~ 15
	81h	0	3	R/W	○	FFC Mode	1	0 ~ 7
	82h	0	2	R/W	○	Select FFC (Gain,Offset)	0	0 ~ 3
	83h	0	1	R/W	○	FFC Corrected Value Output	0	0 ~ 1
	84h	0	16	R/W	○	FFC Data	0	0 ~ 65535
	86h	0	16	R/W	○	FFC Address	0	0 ~ 65535
	88h	0	8	R/W	○	Target FFC Gain	200	0 ~ 255
	8Ah	0	8	R/W	○	Target FFC Offset	3	0 ~ 255
	8Ch	0	8	R/W	○	FFC Corrected Value Store Mode	0	0 ~ 255
	8Dh	0	8	R/W	○	FFC Corrected Value Store Mode(Bank)	0	0 ~ 7
	96h	0	8	R/W	○	Un-detect Chattering Period	0	0 ~ 255
	A7h	0	8	R/W	○	User ID	0	0 ~ 255
	ACh	0	8	R		BUSY	-	0 ~ 255
	B0h	0	16	R/W	○	AOI Start pixel	0	0 ~ 65535
	B7h	0	8	R		STATUS(FFC)	-	0 ~ 63
	C0h	0	16	R/W	○	AOI Width of LVAL	-	0 ~ 65535
	CBh	0	1	R/W	○	Communication Mode	0	0 ~ 1
	E0h	4	1	W		Clear FFC(Gain) RAM	-	0 ~ 1
	E1h	1	1	W		Clear FFC(Offset) RAM	-	0 ~ 1
	E1h	3	1	W		Load FFC(Factory setting)	-	0 ~ 1
	E1h	4	1	W		Set FFC	-	0 ~ 1
	E1h	6	1	W		Save FFC	-	0 ~ 1
	E1h	7	1	W		Load FFC	-	0 ~ 1
	E2h	0	1	W		Save Camera Setting	-	0 ~ 1
	E2h	1	1	W		Resister LOAD(USER->REG)	-	0 ~ 1
E2h	3	1	W		Resister LOAD(FACTORY->REG)	-	0 ~ 1	
Eh	0	8	R/W	○	Output Mode	11	0 ~ 59	

8.4.2 Camera Command Descriptions

The underlined settings are factory default settings.

Command No. Bit No.	Command Description
00h	【Camera Type】 Initial Data: Read Only To output the camera model. C2h: FS-C2KU7DCLUU C6h: FS-C4KU7DCLUU CAh: FS-C8KU7DCLUU

Command No. Bit No.	Command Description															
10h.0-1	<p>【Exposure Mode】 Initial Data:0 To set the exposure mode.</p> <p>0:Line Exposure 1:Fix Exposure 2:Pulse Exposure 3:No function</p>	<p>There are 4 patterns through the combination of Exposure Mode and Sync Mode.</p> <table border="1"> <thead> <tr> <th colspan="2" rowspan="2"></th> <th colspan="2">Sync Mode</th> </tr> <tr> <th>1:External Sync</th> <th>2:Internal Sync</th> </tr> </thead> <tbody> <tr> <th rowspan="3">Exposure Mode</th> <th>0: <u>Line</u></th> <td>External Sync Line Exposure</td> <td rowspan="3">Internal Sync</td> </tr> <tr> <th>1: Fix</th> <td>External Sync Fix Exposure</td> </tr> <tr> <th>2: Pulse</th> <td>External Sync Pulse Exposure</td> </tr> </tbody> </table>			Sync Mode		1:External Sync	2:Internal Sync	Exposure Mode	0: <u>Line</u>	External Sync Line Exposure	Internal Sync	1: Fix	External Sync Fix Exposure	2: Pulse	External Sync Pulse Exposure
		Sync Mode														
		1:External Sync	2:Internal Sync													
Exposure Mode	0: <u>Line</u>	External Sync Line Exposure	Internal Sync													
	1: Fix	External Sync Fix Exposure														
	2: Pulse	External Sync Pulse Exposure														
11h.0-1	<p>【Sync Mode】 Initial Data:2 To set the camera sync.</p> <p>0:No function 1:External Sync <u>2:Internal Sync</u> 3:No function</p> <p>After set this parameter, FFC should be set again for CMOS output character was changed.</p>	<p>External Sync Line Exposure :</p> <p>Exposure Time[us]:Line Cycle-(2+(12*B))</p> <p>External Sync Fix Exposure :</p> <p>Exposure Time [us]:Exposure time setting value*C+2</p> <p>External Sync Pulse Exposure :</p> <p>Exposure Time [us]:Pulse Width of CC1-1</p> <p>Internal Sync :</p> <p>Exposure Time [us]: (Exposure time setting value *C)+A-(2+12*B) Line Cycle [us]: (Exposure time setting value *C)+A</p> <p>[Parameter]</p> <p>A:It depends on output mode</p> <p>B:CLK Cycle</p> <table border="1"> <thead> <tr> <th></th> <th>[us]</th> </tr> </thead> <tbody> <tr> <td>FS-C8KU7DCLU</td> <td>0.0235</td> </tr> <tr> <td>FS-C2KU7DCLU/FS-C4KU7DCLU</td> <td>0.0117</td> </tr> </tbody> </table> <p>C: Step Time</p> <table border="1"> <thead> <tr> <th></th> <th>[us]</th> </tr> </thead> <tbody> <tr> <td>FS-C8KU7DCLU</td> <td>0.4</td> </tr> <tr> <td>FS-C2KU7DCLU/FS-C4KU7DCLU</td> <td>0.2</td> </tr> </tbody> </table>		[us]	FS-C8KU7DCLU	0.0235	FS-C2KU7DCLU/FS-C4KU7DCLU	0.0117		[us]	FS-C8KU7DCLU	0.4	FS-C2KU7DCLU/FS-C4KU7DCLU	0.2		
	[us]															
FS-C8KU7DCLU	0.0235															
FS-C2KU7DCLU/FS-C4KU7DCLU	0.0117															
	[us]															
FS-C8KU7DCLU	0.4															
FS-C2KU7DCLU/FS-C4KU7DCLU	0.2															

Command No. Bit No.	Command Description
12h.0	<p>【Video Out】 Initial Data:0 To set the camera output bit.</p> <p>0:8bit 1:10bit</p> <p>*Configurable output bit are depends on output mode. Some modes are 8bit only.</p>
20-21h	<p>【Exposure Time】 Initial Data:0 To set the camera exposure time.</p> <p>0~65535</p> <p>*When sync control is Internal, Exposure Time becomes a Line period, so you can change the Line period of camera by this setting value of this parameter.</p>
31h	<p>【Digital Gain】 Initial Data:0 To set the Digital Gain.(This process works after received the data from sensor).</p> <p>0~255</p> <p>Digital gain formula is the following.</p> <p>Gained Value =(1 + Digital Gain /64)*(Brightness Level - FFC Offset Target) + FFC Offset Target</p> <p>*This formula is based on FFC. This value is clamped by FFC Offset Target.</p>
34h.0	<p>【Analog Gain】 Initial Data:0 To set the Analog Gain.(This process works on the CMOS's sensor registry).</p> <p>0:OFF 1:ON (x 4)</p> <p>After set this parameter, FFC should be set again for CMOS output character was changed.</p>
78h	<p>【Test Pattern】 Initial Data:0 To set the Test pattern output.</p> <p>0:OFF</p> <p>1:Sawtooth wave 2:Triangle wave 3:Gray Scale 128 Steps 4:Moving Sawtooth wave</p>

Command No. Bit No.	Command Description
81h	<p>【FFC Mode】 Initial Data:1 To set the FFC mode.</p> <ul style="list-style-type: none"> 0:OFF => Non-correction video output <u>1:ON (Gain + Offset)</u> => Corrected video output (Gain + Offset) 2:FFC value => FFC value output on the video signal 3:Manual (by pixel) => Set the correction value into each pixel 4:Manual (all pixels) => Set the correction value into the all pixels 5:Auto (Gain) => Calculate the correct Gain value automatically 6:Auto (Offset) => Calculate the correct Offset value automatically. 7:ON (only Offset) => Corrected video output (only Offset) <p style="text-align: right;">*Camera start the operation when the changing the mode under Auto setting.</p>
82h	<p>【Select FFC (Gain,Offset)】 Initial Data:1 To select Gain or Offset correction value on the Manual Mode of FFC Mode(81h).</p> <ul style="list-style-type: none"> 0:Non <u>1:Gain</u> 2:Offset
83h	<p>【FFC Corrected Value Output】 Initial Data:0 To select FFC corrected value on the FFC value of FFC Mode(81h).</p> <ul style="list-style-type: none"> <u>0:Upper bit</u> 1:Lower bit
84-85h	<p>【FFC Data】 Initial Data:0 To set the corrected vale on the Manual Mode of FFC Mode(81h).</p> <p>0~65535</p>
86-87h	<p>【FFC Address】 Initial Data:0 To set the pixel address data on the Manual Mode of FFC Mode(81h).</p> <p>0~Maximum value (It depends on camera model)</p> <p>*Left side of image is as "0"</p>
88h	<p>【Target FFC Gain】 Initial Data:200 To set the target level(8bit) on Auto (Gain) mode of FFC Mode(81h).</p> <p>0~255</p>
8Ah	<p>【Target FFC Offset】 Initial Data:3 To set the target level(8bit) on Auto (Offset) mode of FFC Mode(81h).</p> <p>0~255</p>
8Ch	<p>【FFC Corrected Value Store Mode】 Initial Data:0 To set the saving mode of FCC corrected value.</p> <ul style="list-style-type: none"> <u>0: User Default Access Area</u> => Use the one corrected FFC value (Automatically changed for output mode) 1: User BANK Area => Select the several corrected FFC value <p>*Under the Standard setting, corrected FFC value will be loaded automatically, if signal wave is changed for each output mode. As for the detail, please refer to the FFC Corrected Value Store Mode.</p>

Command No. Bit No.	Command Description									
8Dh	<p>【FFC Corrected Value Store Mode(Bank)】 Initial Data:0 To set the Bank number on Bank Mode of FFC Corrected Value Store Mode(8Ch). 0~7 *FFC value would not be loaded automatically even changing this setting.</p>									
96h	<p>【Un-detect Chattering Period】 Initial Data:0 To set the time period of un-detect chattering. This function can be used the input trigger signal from CC1. The trigger is recognized through consecutive this number of high signal (by CLK) . 0~255</p>									
A7h	<p>【User ID】 Initial Data:0 To set the User ID. When several cameras are using, each camera can be assigned the specific name. 0~255</p>									
ACh	<p>【BUSY】 Initial Data: Read Only To understand the communication status. 0: Enable the communication 1~255: Disable the communication</p>									
B0-B1h	<p>【AOI Start Pixel】 Initial Data:0 To set the start Pixel position. Maximum value depends on sensor size. As for the available mode, please refer to the FS-B2KU7CLU,FS-B4KU35CLU,FS-B4K7CLU,FS-B8KU35CLU,FS-B8KU7CLU,FS-B16KU35CLU.</p>									
B7h	<p>【STATUS】 Initial Data : Read Only To read the FFC status.</p> <table border="1"><tr><td>D[7:0]</td><td>D7</td><td>D6</td><td>D5</td><td>D4</td><td>D3</td><td>D2</td><td>D1</td><td>D0</td></tr></table> <p>D7-5:No-function D4:Status of Shield light level D3:FFC Gain over D2:FFC Gain short D1:FFC Offset over D0:FFC Offset short</p> <p>0: Fix 0: Normal 0: Normal 0: Normal 0: Normal</p> <p>1: Shield light level is always 0 1: Light receiving level is higher than Target level(Gain) 1: Light receiving level is lower than Target level(Gain) 1: Shield light level is bigger than maximum offset 1: Shield light level is lower than Black level</p>	D[7:0]	D7	D6	D5	D4	D3	D2	D1	D0
D[7:0]	D7	D6	D5	D4	D3	D2	D1	D0		
C0-C1h	<p>【AOI width of LVAL】 Initial Data: Maximum of pixel number for each model To set the valuable length on AOI image. Maximum value depends on sensor size. As for the available mode, please refer to the FS-B2KU7CLU,FS-B4KU35CLU,FS-B4K7CLU,FS-B8KU35CLU,FS-B8KU7CLU,FS-B16KU35CLU.</p>									

Command No. Bit No.	Command Description
CBh.0-1	<p>【Communication Mode】 Initial Data: 0 To set the Specific Communication Mode. Please set this parameter "ON", when external sync does not input camera. 0:OFF Normal Mode (Communication just only work with external sync) 1:ON Specific Communication Mode (Internal Sync mode without video image output) 2-3:Invalid</p>
E0h.4	<p>【Clear FFC(Gain) RAM】 Initial Data: Write Only To clear the FFC Gain data on the RAM. Set "1"</p>
E1h.1	<p>【Clear FFC(Offset) RAM】 Initial Data: Write Only To clear the FFC Offset in data on the RAM. Set "1"</p>
E1h.3	<p>【Load FFC(Factory setting)】 Initial Data: Write Only To load the FFC Gain(Factory setting). Set "1"</p>
E1h.4	<p>【Set FFC】 Initial Data: Write Only To set the FFC value when FFC Manual mode was selected(81h). Set "1"</p>
E1h.6	<p>【Save FFC】 Initial Data: Write Only To save the FFC Gain value into the RAM. Set "1"</p>
E1h.7	<p>【Load FFC】 Initial Data: Write Only To load the FFC Gain from RAM. Set "1"</p>
E2h.0	<p>【Save Camera Setting】 Initial Data: Write Only To save the camera setting data into the RAM. Set "1"</p>
E2h.1	<p>【Load Camera Setting】 Initial Data: Write Only To load the camera setting data from RAM. Set "1"</p>
E2h.3	<p>【Load Camera Setting (Factory Default)】 Initial Data: Write Only To load the factory default setting from RAM. Set "1"</p>
EEh	<p>【Output Mode】 Initial Data: It depends on camera model To set the camera output mode. Therefore it could be selectable of Camera link Full/Medium/Base configuration, Camera Link output CLK.</p> <p>Selectable Output Mode is different for each model. As for the detail, please see FS-B2KU7CLU,FS-B4KU35CLU,FS-B4K7CLU,FS-B8KU35CLU,FS-B8KU7CLU,FS-B16KU35CLU,Minimum line period</p> <p>*8bit (Fix)/10bit output can be selected through Output Mode. *Maximum Frame rate on Internal Sync can be selected through Output Mode. *FFC would be changed automatically through Output Mode when FFC Corrected Value Store Mode is Standard.</p>

8.4.3 Save the Camera Setting Data into FLASH

To save the camera setting data into FLASH, please follow the procedure below:

- Set "1" on E2h.0 to save the camera setting.

8.4.4 Sequence of Camera Power On

- 1) Power the camera on.
- 2) Load the camera setting into the registry and storage FLASH RAM.
- 3) Corrected FFC values load from FLASH.

9. Control Software Manual

9.1 Control Software

- CLCtrl2 Version 1.04 or later.
- If the camera connected is not “Field Update” capable, please install the “LineSensorCommunicationTool” Software provided by Sentech.

9.2 Summary

After installing the control software and launching the CLCtrl2.exe, the main window appears as below. [**H] right side of each function is the actual register address.

The screenshot shows the CLCtrl2 v1.04 Beta11 software interface. The window title is "CLCtrl2 v1.04 Beta11 [CISerBit.dll(0) - 5.4.0.0 - LinX Corporation - Port #0 - 115,200bps]". The interface is divided into several sections: "Basic", "FFC", "STATUS", and "Firmware".

- Basic:** Contains settings for Speed / Output format, Synchronization mode, Exposure mode, Output bit setting, Electrical Shutter, Exposure Time, Line Rate, Digital Gain, Analogue gain, Test pattern, and User id.
- FFC:** Contains FFC Mode, FFC Target level (Gain and Offset), and buttons for Clear RAM of gain and offset.
- STATUS:** Contains a refresh button and EEPROM save/load buttons for normal user and factory settings.
- Firmware:** Contains FFC Coefficients output and Normal/Bank user setting options.

At the bottom of the window, there are four buttons: "Read all", "Register->EEPROM", "EEPROM->Register", and "Factory->EEPROM".

Callout boxes provide the following explanations:

- Menu:** As for the detail, please refer to the next page.
- Camera Setting Parameters:** As for the detail, please refer to the next chapter.
- EEPROM->Register:** Load the factory saved settings data to EEPROM. As for the detail, please refer to the next chapter [Comm.](#)
- Register->EEPROM:** Load the previously saved settings data from EEPROM to Register. As for the detail, please refer to the next chapter [Comm.](#)
- Read all:** Read the camera setting data from Register. As for the detail, please refer to the next chapter [Comm.](#)
- Factory->EEPROM:** Save the camera setting data on the register to EEPROM. As for the detail, please refer to the next chapter [Comm.](#)

Note: The Window design may slightly change in future revisions.

9.2.1 File

Open[From File to Register]

Open the camera setting file (.i2c).

Save as[From Register to File]

Save the current camera setting data on the register to the PC as a .i2c file.

Open[From File to EEPROM]

Open the camera setting file (.i2c) that is read at power on.

Save as[From File to EEPROM]

Save the camera setting data on the EEPROM to the PC as a.i2c file.

Quit

Exit the control software.

9.2.2 Common

Port Setting

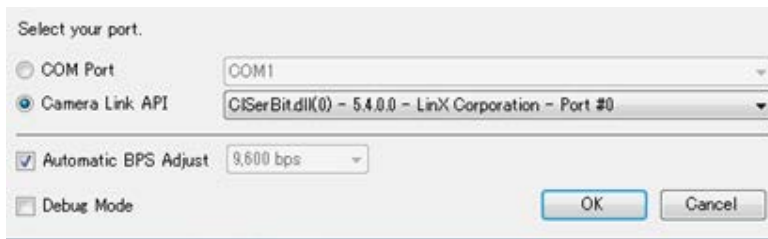

[Select your port]

When the Frame Grabber supports COM port, please select the “COM Port” command.

When the Frame Grabber supports Camera Link API, please select the “Camera Link API” command.

[Automatic BPS Adjust]

Select the serial communication speed automatically. When the box is un-checked, the communication speed can be selected manually.

[Debug Mode]

This box is un-checked as a default. When the box is checked, the transfer data can be monitored through third party software.

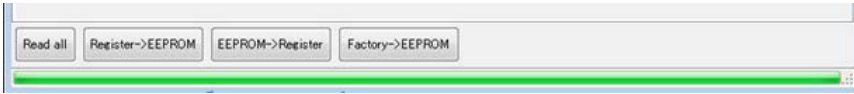

Read All

Read the settings of all data from the camera register. This setting data on the register cannot be saved without saving the EEPROM (Register → EEPROM).

Register → EEPROM

Save the register data into the EEPROM on the camera. When the camera turns off, the data remains on the EEPROM.

EEPROM → Register

Read the EEPROM data into the register. When user wants to access the saved data, this can be used.

Factory →EEPROM

Restore the factory setting data from the EEPROM to the register.

9.2.3 Mode

Language

Select the language. The user can choose between English or Japanese.

9.2.4 Help

Advanced Operation

When the user wishes to access the advanced features of the software, please input the password "sentechcamera". The SP Pin tab can now be used.

Version Information

Software information window appear.

9.3 Standard Tab

9.3.1 Basic

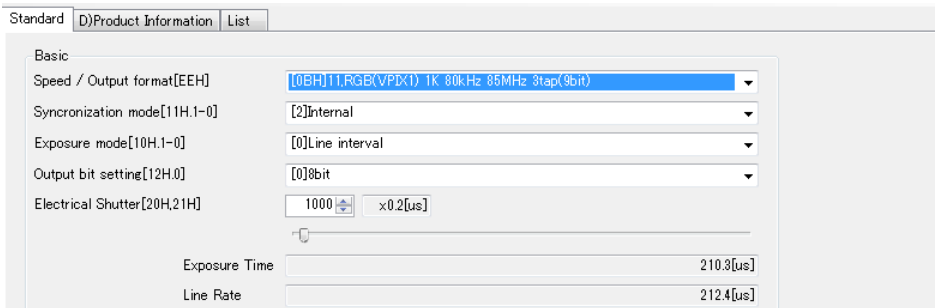

Speed / Output Format

This command sets the camera output mode. Frame rate can be determined by Selectable clock speed & TAP number. The modes that are available will differ depending on the camera model used.

Synchronization Mode

This command allows the user to select the camera sync.

- [1] External: External Sync
- [2] Internal: Internal Sync

Exposure Mode

This command allows the user to select the exposure mode.

- [0] Line Interval: The exposure occurs during a variable line period.
- [1] Edge Preset: The camera exposure starts at the rising edge of the trigger pulse and the exposure will end after a certain amount of time.
- [2] Pulse Width: The camera exposure starts at the rising edge of the trigger pulse and stops at the falling edge of the trigger pulse.

Output bit setting

This command allows the user to select the camera output bit.

- [0] 8 bit
- [1] 10 bit

Electrical Shutter

Electrical shutter can be set through the slide bar or set through the actual register rvalue. Actual exposure time appears on the bottom right of the slide bar.

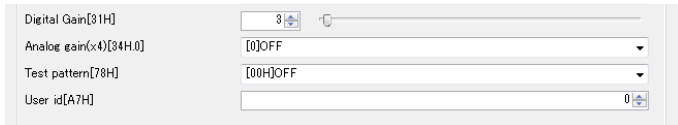

Digital Gain

Digital gain can be set through the slide bar or set through the actual register value.

Analog Gain

This command allows the user to select the Analog Gain (x4)

[0] OFF: x1

[1] ON: x4

Test Pattern

This command outputs the test pattern on the image.

User ID

This command allows the user to assigned a number 0 to 255 as the ID.

9.3.2 FFC

Conceptual Figure of FFC Camera

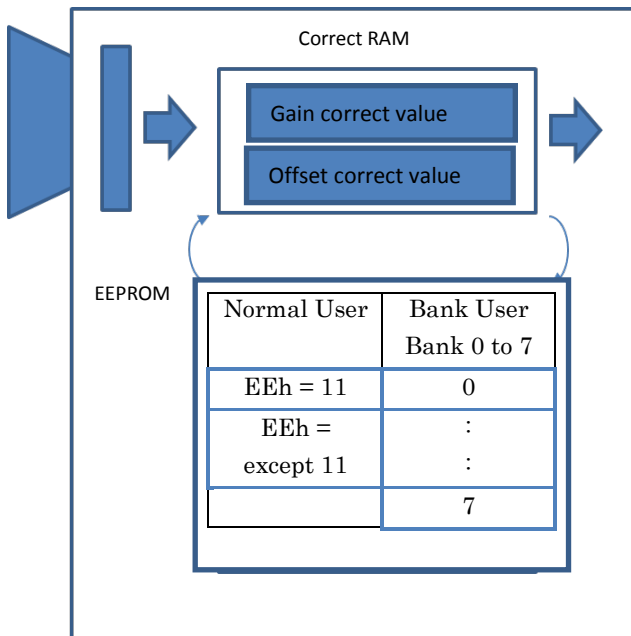

Glossary

Correct RAM:

- blah
- The gain and offset value can be stored on each RAM.
- Once the camera has powered off, data will be erased.

EEPROM(FLASH Memory):

- blah
- Normal user and Bank user have own address.
- Once the camera has powered off, the data will be saved.

Normal User: Output mode(EEh)=11/except two(*1)

Bank User: 8 bank (*1)

*1: In this case, Gain and Offset is one pair and count as one.

FCC ON / OFF

FFC Mode

[1] ON(Gain + Offset): FFC Enable

[0] OFF: FFC Disable

FFC

FFC Mode[81H,2-0] [1]ON(Gain+Offset) ①

FFC Target level(Gain)[88H] Digit(8bit) Clear RAM of gain[E1H.1]

FFC Target level(Offset)[8AH] Digit(8bit) Clear RAM of offset[E0H.4]

STATUS[87H]

EEPROM save for normal user[E1H.6]

EEPROM load for normal user[E1H.7]

EEPROM load for factory setting[E1H.3]

FFC Coefficients output(gain or offset)[82H.1-0]

FFC Coefficients output Bit[83H.0]

Normal/Bank user setting[8CH]

BANK setting[8DH]

Set data[E1H.4]

FFC Address[86H,87H]

FFC Data[84H,85H]

Set Correct Value

Set the correct value. (Unit: Digit at 8bit)

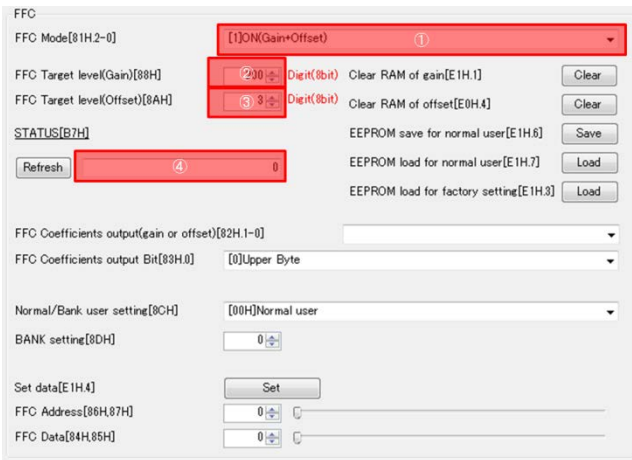

[Auto Setting]

This command will set the target level of offset correction for shielded light and gain correction on unshielded light automatically. The offset settings have to be done before set up begins.

[Offset]

1) Set FFC Target Level (Offset) on ③

e.g.: 3

Note: This value should follow the formula: "FFC Target Level(Gain) > FFC Target Level(Offset)".

2) Shield the light.

3) Start offset correction → select "[6] Auto Setting for Ofset" on ①.

Note: Set the [6] from rest of number.

4) When the progress bar has completed the correction is done.

[Gain]

5) Set FFC Target Level(Gain) on ②

e.g.: 200

Note: Please follow the formula: "FFC Target Level(Gain) > FFC Target Level(Offset)".

6) Un-cover the sensor.

7) Check that the resulting light level received is lower than the target level → Seletc "[7]ON(Offset only)" on ①. Check the corrected image.

Note: Only +Gain is available.

8) Auto Gain Correction → Select "[5] Auto Setting for gain" on ①.

Note: Set the [5] from rest of number.

9) When the progress bar has completed the correction is done.

10) Check that the auto correction completed → Status should be 0 on ④.

Note: If the status does not show "0", the FFC setting is not complete. Restart the procedure.

11) Set "[1] ON(Gain + Offset" on ①.

[Manual Setting (per Pixel)]

Set the correction value on a specific pixel position.

- 1) Set “[3] Set Value Each Pixel” on ⑩.
- 2) Set “Gain/Off set” on ⑤.
- 3) Set the pixel position on ⑩ → It is possible to set the position through the slide bar as well.
- 4) Set the correction value on ⑪.
- 5) Reflect the correction value into the RAM → Click ⑨.



[Manual Setting (All Pixels)]

Set the correction value on all pixels at one time.

- 1) Set “[4] set Value All Pixel” on ①.
- 2) Set “Gain/Off set” on ⑤.
- 3) Set the correction value on ⑪.
- 4) Reflect the correction value into the RAM → Click ⑨.

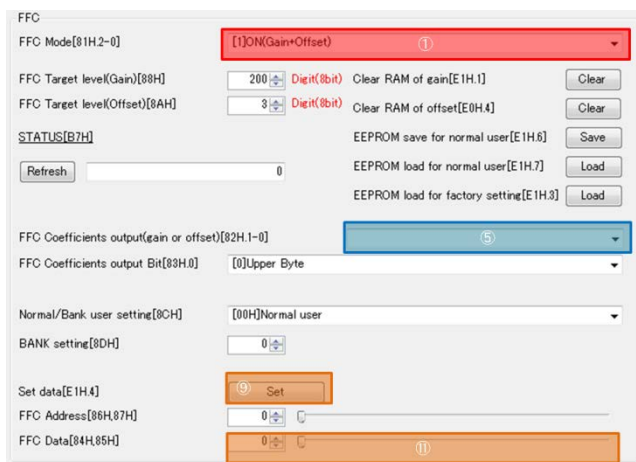

Check the Value

Output the video that has corrected RAM value.

- 1) Set “[1] Setting Value Out” on ①.
- 2) Set “Gain/Off set” on ⑤.
- 3) Select “Upper Byte” or “Lower Byte” of FFC coefficient on ⑥.
- 4) The output video image should show the corrected value for each pixel.



Clear RAM

Clear the corrected value on RAM.

- In order to clear Gain → Click ⑫.
- In order to clear Offset → Click ⑬.

Load to Factory Default

This command will reset the RAM to factory default settings.

- In order to reset to Factory Default → Click ⑯.

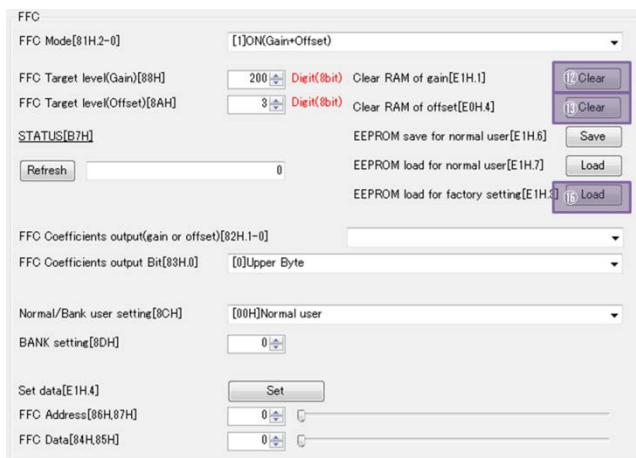

Save / Refer the Correct Value

Save / Refer the correct value into the FLASH

[Normal User]

When the camera is used under single condition, this mode should be selected.

1) Select Normal User mode → Select “00H Normal User” on ⑦.

- In order to save the setting into EEPROM → Click ⑭.

- In order to load the setting from EEPROM → click ⑮.

Note: FFC data is stored on two addresses (Output mode(EH)=11 or another). The address is determined from Output mode(EH) regardless of bank number.

Note: Switching the (Output mode(EH)=11 or another), FFC correct value would be reflected automatically.

FFC

FFC Mode[81H.2-0] [1]ON(Gain+Offset)

FFC Target level(Gain)[88H] 200 Digit(8bit) Clear RAM of gain[E1H.1] Clear

FFC Target level(Offset)[8AH] 3 Digit(8bit) Clear RAM of offset[E0H.4] Clear

STATUS[B7H]

Refresh 0

EEPROM save for normal user[E1H.6] ⑭ Save

EEPROM load for normal user[E1H.7] ⑮ Load

EEPROM load for factory setting[E1H.3] Load

FFC Coefficients output(gain or offset)[82H.1-0]

FFC Coefficients output Bit[83H.0] [0]Upper Byte

Normal/Bank user setting[8CH] [00H]Normal user ⑦

BANK setting[8DH] 0

Set data[E1H.4] Set

FFC Address[86H.87H] 0

FFC Data[84H.85H] 0

[Bank User]

When the camera is used under multiple conditions, this mode should be selected.

- Select Bank User mode → Select “01H Bank User” on ⑦.
- Select the store BANK → Set the bank number on ⑧.
- In order to save the setting into the EEPROM → Click ⑭.
- In order to load the setting from the EEPROM → Click ⑮.

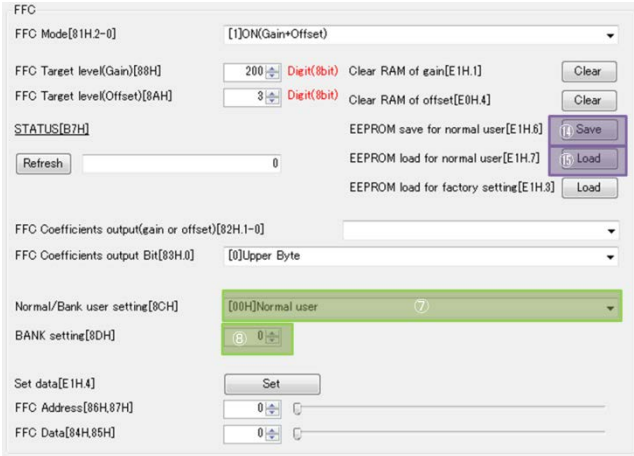

9.3.3 Chattering

Dead time Chattering

9.3.4 1 Line Delay

Single line data outputs from the Dual line sensor.

Therefore it provides the correction of the measurement point difference on Dual line.

Delay line can be selected through the register BAh.

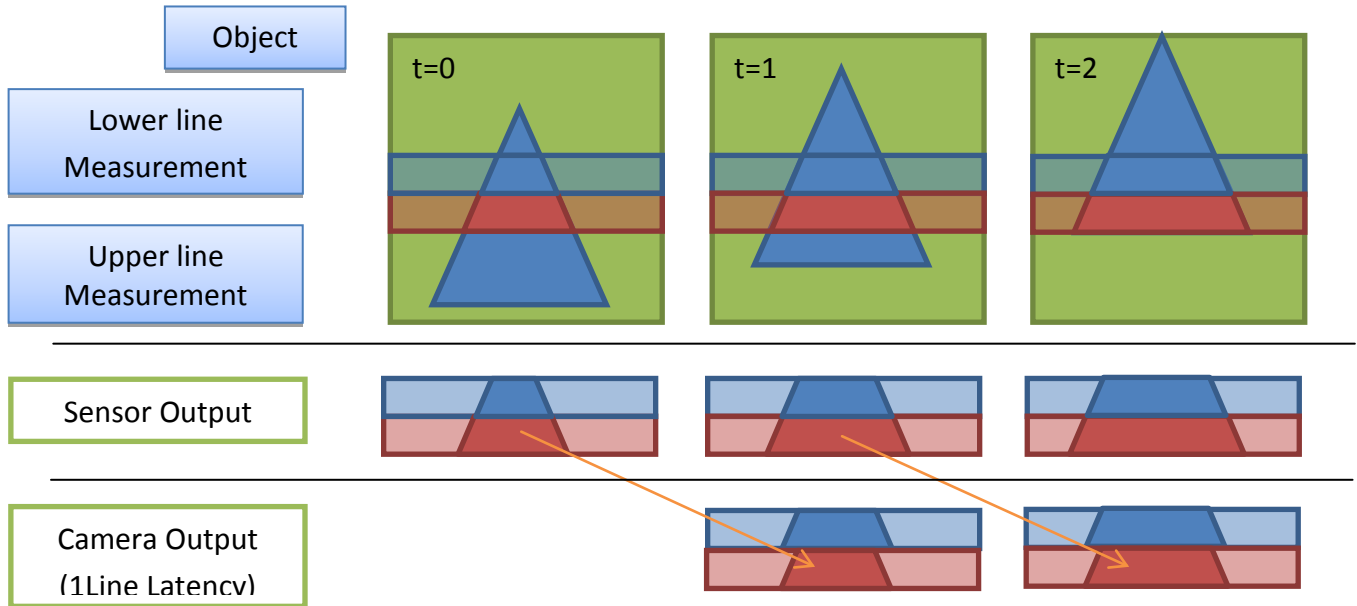

10. Field Update Function

Camera FPGA data can be overwritten via PC (Field Update).

10.1 Procedure

- 1) Launch the update software “StCLRemoteUpdate”
- 2) Select the update file (.rbf) and COM port communicate with the camera and click “Update”.

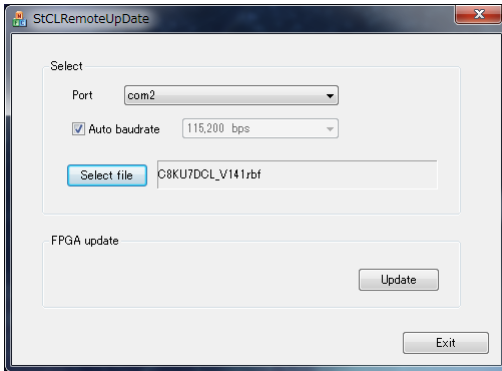

- 3) When the upload is finished, power the camera on / off.

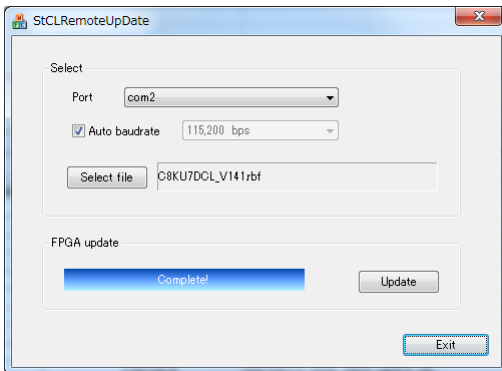

11. Quantum Efficiency

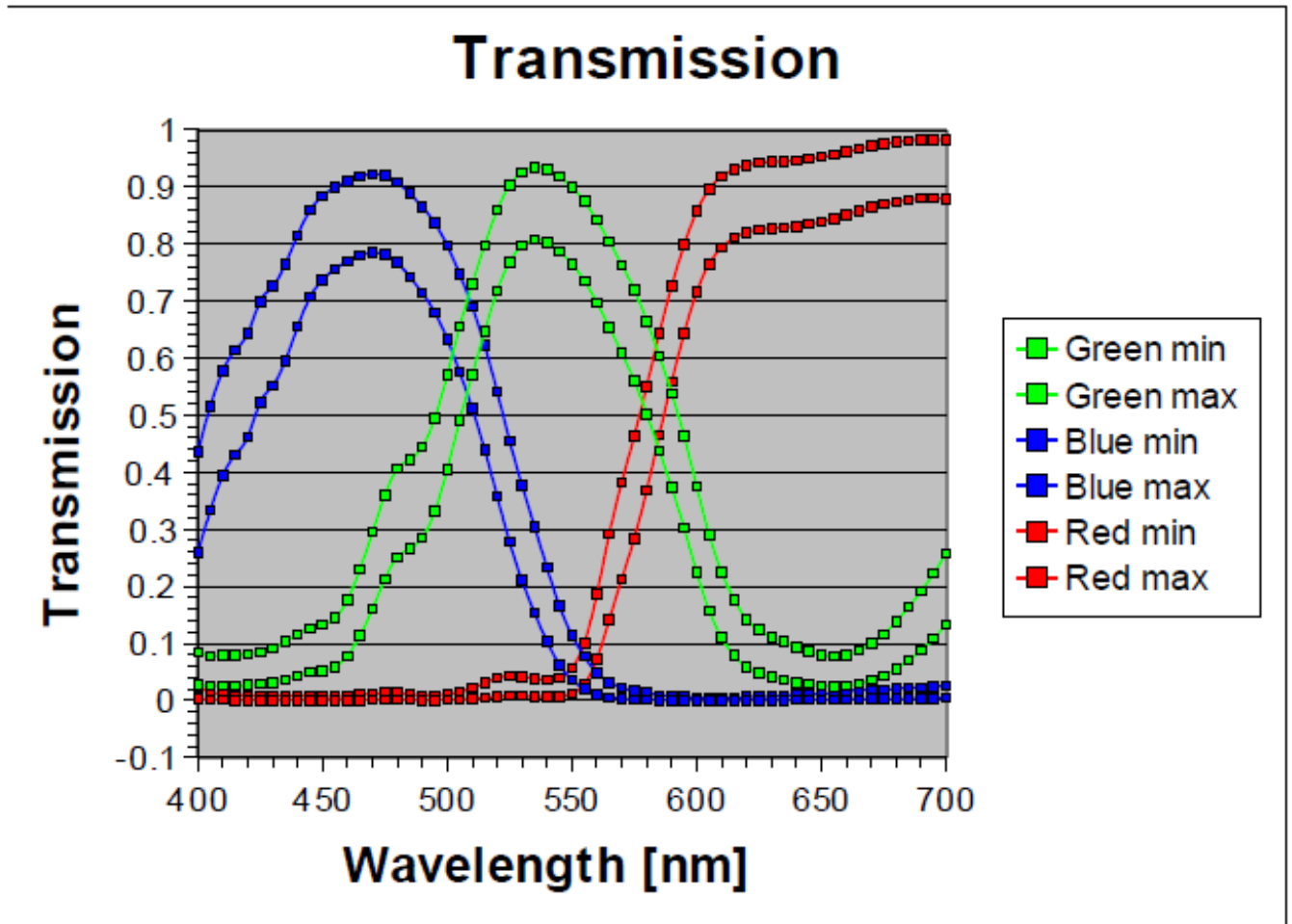

12. Dimensions

12.1 FS-C2KU7DCL-C

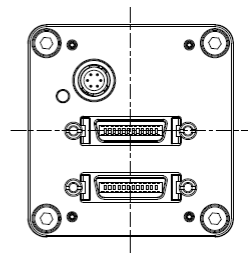
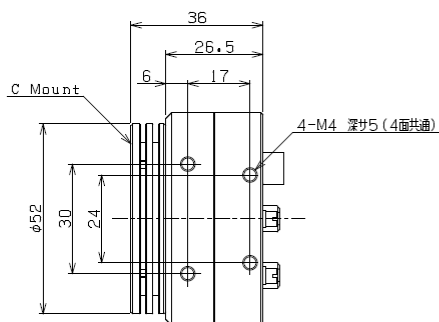
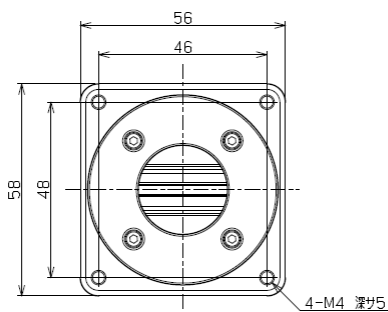
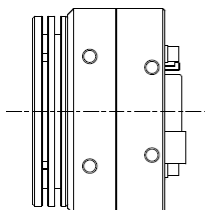
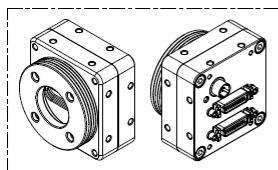

12.2 FS-C2KU7DCL-F

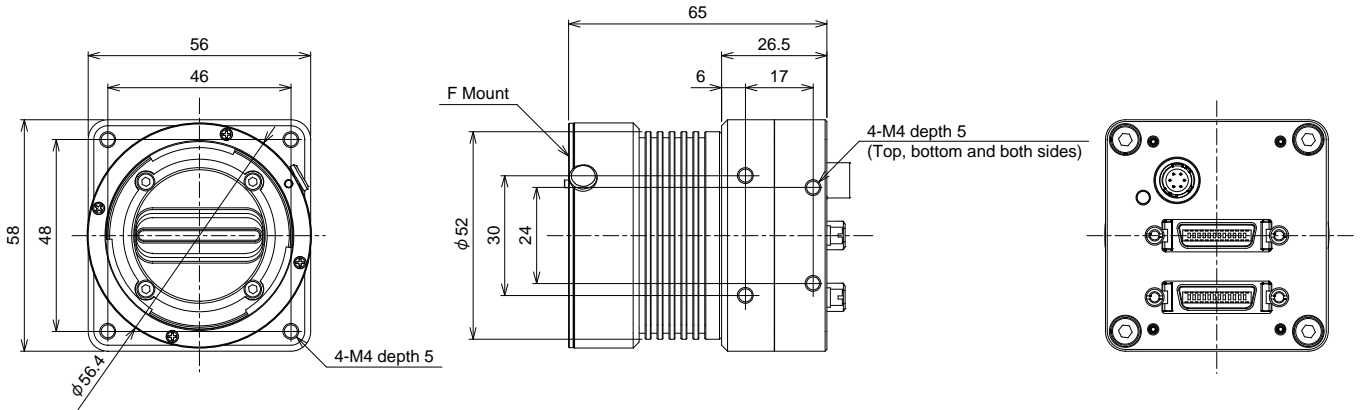
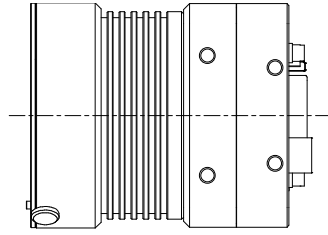
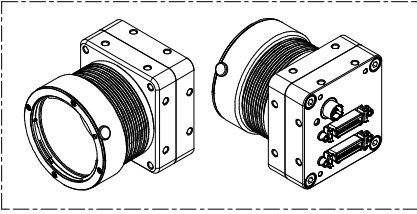

12.3 FS-C4KU7DCL-F

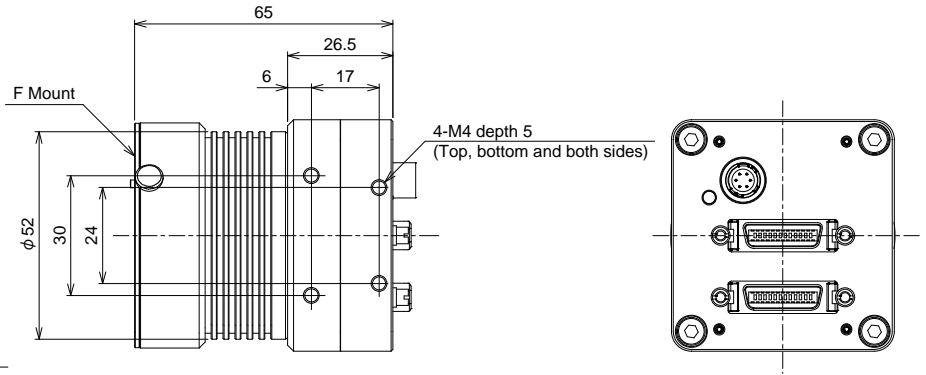
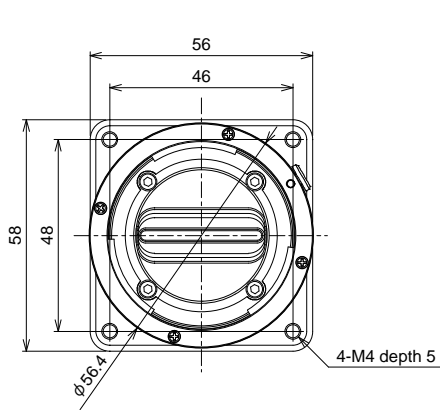
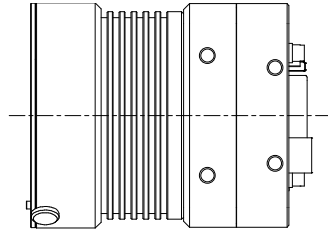
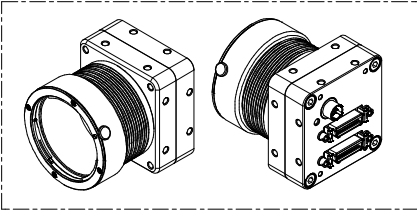

12.4 FS-C8KU7DCL-M72

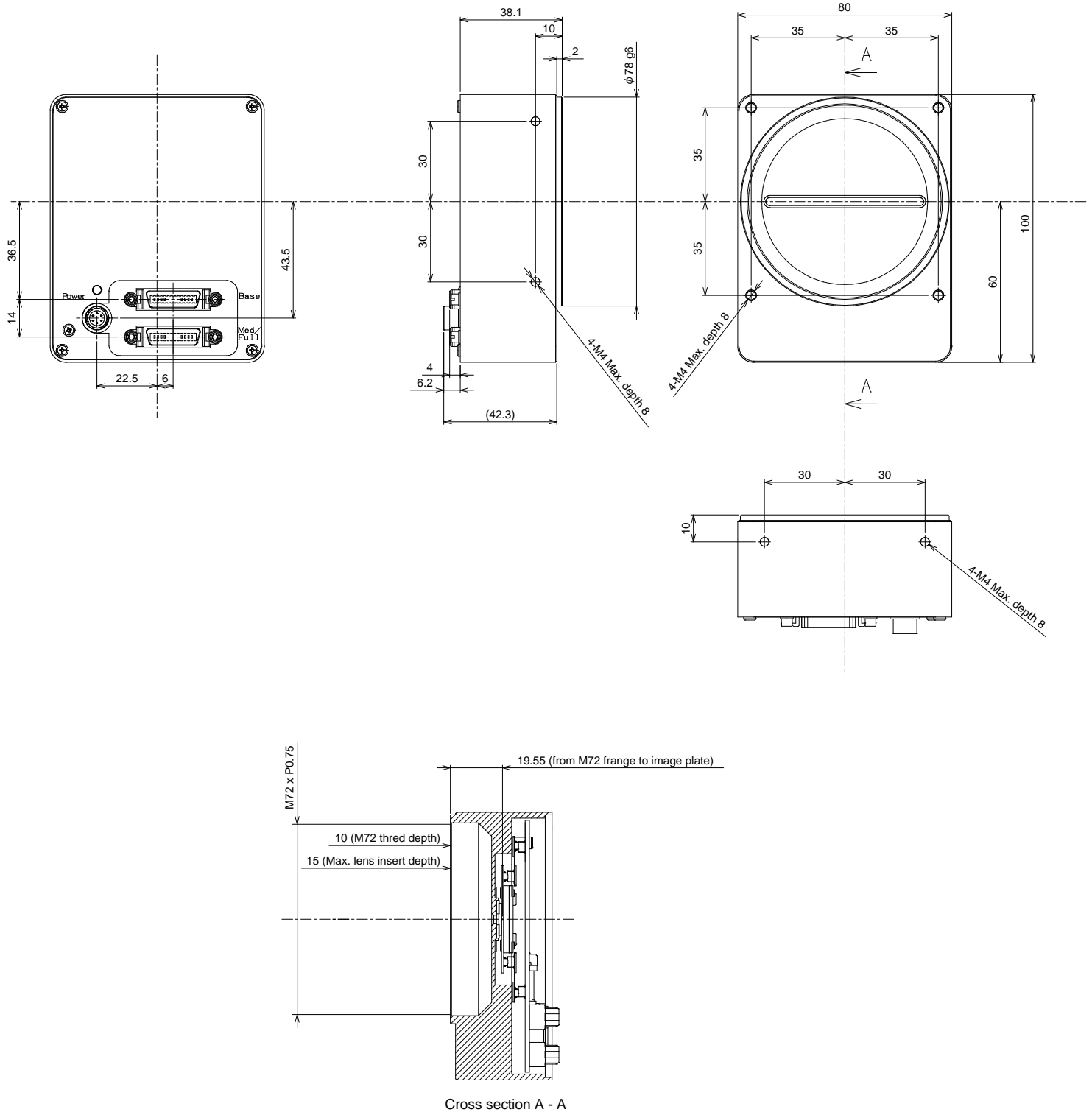

Revisions

Rev	Date	Change	Notes
1.00	May 29, 2012	New Doc	
1.03	November 27, 2012	Update Added Explanations for Chapters 4,5,6 Revised Timing Charts	
1.04	January 23, 2013	Update	
1.05	April 24, 2013	Edited Version Number	
1.06	August 1, 2013	Update	
1.08	April 28, 2014	Updated to Field Update Version	